

Instrumentation and monitoring of underground structures and metro railway tunnels

V.K. Rastogi

Encardio-rite Electronics Private Limited, Lucknow, India

SYNOPSIS: The observations of engineering properties during geotechnical construction are an integral part of the design of underground structures. The Paper presents Instrumentation as a tool to assist with these observations. From the measurements taken, the need for modifications to the loading or support arrangements is determined. Apart from above construction control, instrumentation is also indispensable for site investigation, design verification and safety of the structure.

Metro Railway Tunnels, being in populated area, have a more comprehensive instrumentation and monitoring program that additionally includes monitoring of ground conditions, underground water levels, tilt & settlement of nearby buildings or other structures of interest in the vicinity of the tunnel alignment. Instrumentation monitoring for Metro Railway Tunnels includes monitoring of the structures under construction together with the ground, buildings and other facilities within the predicted zone of influence.

The Paper presents the features of sophisticated instrumentation available today for geotechnical monitoring. A wide range of sophisticated electronic & mechanical instrumentation have been described with their applications with different instrumentation schemes used to meet the requirements of different types of structures. These world class instruments are extensively manufactured in India and exported all over the world. The features and usefulness of instrumentation for different types of Underground Structure and Metro Railway Tunnels have been discussed. Case Studies from projects executed by the author are described. The author has presented data obtained from instrumentation used and highlighted the usefulness of instrumentation monitoring in achieving economy, better control of construction, design verification and safety of the structures.

1. NECESSITY OF GEOTECHNICAL INSTRUMENTATION

The designer of geotechnical construction works with naturally occurring materials, and does not know their exact engineering properties. He may carry out tests in the laboratory on the samples picked up from the field, and sometimes change the naturally occurring materials to make them more suitable for his needs. But his structural design will essentially be based on the values of engineering properties of the materials tested by him. Therefore, as construction progresses and exact geotechnical conditions observed or behaviour monitored by means of instrumentation, the design judgments are evaluated and changes made, if necessary. Hence observations by means of monitoring instruments during geotechnical construction are an integral part of the design process. Instrumentation is a tool to assist with these observations. They are our eyes and ears inside the rock.

Instrumentation is used to measure the response (deformation, stress etc.) of soil or rock to changes in loading or support arrangements, and from the measurements taken, the need for modifications to the loading or support arrangements is determined. This illustrates the basic reason why instrumentation is generally of immense value during geotechnical construction.

1.1 *Purpose of good instrumentation*

A good instrumentation program should have one or more of the following purposes in mind:

1.1.1 *Site investigation*

Instruments are used to characterize and determine initial site conditions. Common parameters of interest in a site investigation are pore pressure, permeability of soil, slope stability etc.

1.1.2 *Design verification*

Instruments are used to verify design assumptions. Instrumentation data from the initial stage of a project may show the need or provide the opportunity to modify the design in later stages. For example, data obtained from NATM shotcrete cells in the initial stretch of tunnel is used to revise the thickness of shotcrete in the later stages.

1.1.3 *Construction control*

Instruments are installed to monitor the effects of construction. Instrument data helps the engineer to determine how fast construction can proceed without adverse effects on the foundation soil and construction materials used. For example, in tunnel construction, the data obtained from the load cells helps the geotechnical engineer to know if the stresses in the excavated tunnel have been stabilized and how fast he can proceed with further excavation.

1.1.4 *Safety*

Instruments can provide early warning of impending failure. In case of metro railway tunnels instruments provide early warning through real time monitoring systems available on the internet for any excessive and undue ground movements affecting the adjoining premises, structure and utilities like the railways, power lines, water lines etc. within the zone of influence of the excavations or tunnels. This allows for implementation of preventive remedial actions well within time.

1.1.5 *Legal protection*

Instruments provide designers and contractors the basis of a legal defence should resident and owners of adjacent properties blame construction for damage to their property and life. This aspect gains prominence in constructions in populated areas such as for underground metro railways.

1.1.6 *Performance*

Instruments are used to monitor the in-service performance of a structure. For example, monitoring leakage, pore water pressure and deformation can provide an indication of the performance of a dam. Monitoring loads on rock

bolts and movements within a tunnel can provide an indication of the stability of tunnel.

2. INSTRUMENTS FOR UNDERGROUND STRUCTURES & METRO RAIL TUNNELS

2.1 *Bore hole extensometer to measure deformations of rock mass*

It is used to measure deformation of a section of rock mass and adjacent surrounding soil with respect to a deep anchor. The depth of anchor varies with the type of rock strata and the location of the fixed point with respect to which the deformations are to be measured. In order to assess deformations and stress changes of different sections of rock mass, multi point bore hole extensometers (MPBX) as compared to single point bore hole extensometers (SPBX) are used. MBPX contains a number of anchors (2 to 6) at different depths. The displacement ranges commonly used are from 50 to 150 mm. SPBX and MPBX are available in both mechanical and electronic types. The electronic version is preferred in applications where access at the head of the extensometer for the purpose taking reading is not easily available. Also with electronic types, it is possible to read a number of instruments automatically at predefined intervals with the help of a remote Data Acquisition System. The cabling to the electronic SPBX or MPBX, and the instrument itself, has to be carefully protected during excavation and blasting. Cable free instruments are also now being tried to do away with the difficulties of cable protection.

2.2 *Load cell to measure load in rock bolts*

Load cell with a hole in the centre is used to determine load in rock bolts and tieback anchors etc. It is installed at the surface of the underground cavern around the rock bolt or tie back anchor with the help of top and bottom plates. It comprises of a number of electronic sensors (vibrating wire or resistance strain gage type) mounted around the circumference of the load sensing element. Load cells like other sensors need proper protection against adverse conditions that are encountered at construction sites. Our strain gage type load cell is hermetically sealed by electron beam welding with a vacuum inside it making it immune to ingress of water and to most corrosive environments. The load range commonly available is upto 5000 kN.



Photo 1 A pair of Encardio-rite model EDS-30V shotcrete strain gages and convergence bolt of an optical target installed before shotcreting of an NATM tunnel.

Hydraulic type centre hole load cells are also available with mechanical dial gage readout.

2.3 Load cell to measure stress in ribs and struts

Compression load cells are available for ascertaining forces in the struts. In case of ribs used in tunnels or underground cavities to support the roof, generally two load cells are mounted at the ends of the rib at its two bases and a third load cell is mounted at the crown of the rib. For mounting the load cell at the crown, flanges are provided at the two cut ends at the top of the rib. The load cell base plates are bolted to the flanges. Two additional load cells may be mounted at 45° sections on the rib. As in the case of centre hole load cells, these load cells are also available in vibrating wire or strain gage types upto 5000 kN capacity.

In cut and cover areas where struts are used, load cells are used to measure actual loading on the struts as construction progresses. Generally, two

flanges are made on the strut at a distance of around 1/4th from the ends and the two load cells are mounted between these two flanges.

2.4 Strain gage to measure strain in ribs and struts

Vibrating wire strain gage (gage length 140 mm) can be arc welded for measurement of strain/stress in ribs and struts. Two annular mounting blocks are provided for arc welding the strain gage on to the strut or rib. The sensor is of stainless steel construction and has waterproofing to prevent any ingress of water. Spot weld able strain gages with shorter gage lengths (50 mm) may be used on struts. The spot weld able gages can also be epoxy bonded to the struts by using proper epoxies. The measurement range normally used is upto 3000 micro strain.

Strain gages indirectly determine the loading on the strut or ribs. They are simpler to use than load cells and also cost less. They are therefore used

more extensively with load cells also being used at representative number of struts/ribs for verification and co-relating data between the two.

2.5 *Strain gage to measure strain in shotcrete (Photo 1)*

Vibrating wire embedment strain gages are used with a range of 3000 μ strain. Shotcrete strain gages with a range of upto 15,000 micro strain is also available for specific uses. Installation of two such strain gages is shown in Photo 1.

2.6 *Shotcrete-concrete stress cell to measure stress in shotcrete*

NATM style shotcrete-concrete stress cell designed for measurement of radial and tangential stresses in shotcrete tunnel lining. The cell consists of a rectangular pressure pad constructed from two stainless steel plates welded around the periphery. The pressure pad is connected to the vibrating wire pressure sensor through a stainless steel tube. The cavity inside the pressure pad and pressure sensor is filled with de-aired fluid. A pinch tube or regrowable arrangement is provided to inflate the pressure pad after concrete around it has fully cured, to ensure proper contact between pressure pad and surrounding concrete. It is available in different ranges upto 30 MPa.

2.7 *Pore pressure meter to measure pore water pressure around tunnel and underground*

NATM style shotcrete-concrete stress cell designed for measurement of radial and tangential stresses. Vibrating wire type pore pressure meters are installed by drilling holes in tunnel section or underground cavities to monitor any increase in pore water pressure that might result in weakness of the surrounding rock or soil. Mechanical measurements may be carried out by Casagrande piezometers or standpipes using a dip meter. These instrument find common applications in metro rail tunnels.

2.8 *Convergence measurement by mechanical methods-tape extensometer*

Tape extensometer is designed to measure small changes in distance between two reference points in any orientation, to give deformation of underground openings, excavations, tunnels, roof of a mine,

movements of unstable slopes, etc. The readings are displayed on a 5 digit LCD display.

2.9 *Convergence measurement by optical methods-Bireflex and Prism Targets (Photo 1)*

Optical bireflex or prism targets are widely used to monitor convergence of tunnels or slopes. The target is screwed on to a steel bolt grouted in the structure and the location of the target in the three dimensions is accurately determined by means of Total Stations.

2.10 *Inclinometer and magnetic settlement devices (Fig 11 for typical data)*

Inclinometers, magnetic settlement devices and Inclinometer-cum-magnetic settlement devices are very commonly used to monitor lateral movements (x and y directional movements) and settlements (z directional movements) around a tunnel excavation or on a slope. These instruments provide valuable information about small movements taking place underground such that necessary corrective actions are taken well in time before a catastrophe occurs.

2.11 *Measuring Anchor to measure distribution of load exerted on grouted rock bolts*

Measuring anchor, also known as rock bolt extensometer, is a combination of rock bolt and extensometer. It is used to determine load exerted on grouted rock bolts. It is a precision instrument designed to evaluate anchor system forces and their distribution within the bolt and hence its safety and effectiveness. A digital calliper/micrometer depth gage with a resolution of 0.01 mm is used to take readings. An electrical head assembly consisting of potentiometric sensors is optionally available.

3. MONITORING SCHEMES FOR UNDERGROUND STRUCTURES

Any point on the surface of a mountain is subjected to stresses in two directions, the stress in a direction perpendicular to the surface being zero. Any point inside the mountain, if not next to a void or cavity,

is subjected to stresses from all the directions. Excavation of any cavity inside a mountain, like making of an underground power house or boring of a tunnel, results in the release and readjustment of these three dimensional stresses around the cavity. Readjustment and release of stresses results in displacements. These displacement are also time dependent. The forces of gravity acting on the excavated surface and the stresses released behind the surface, result in instability which requires the supporting of the cavity. There are many methods by which the roof and side walls of excavated cavities can be supported. One of the methods by which the roof of excavated cavities can be supported is by providing arched ribs made of heavy duty steel sections. Another method called the New Austrian Tunnelling Method (NATM) is

by applying a thick layer of shotcrete around the excavated area that quickly solidifies and supports the excavation. The instrumentation for underground cavities varies widely with the type of construction methodology used, the nature of rock obtained, the size (width) of the underground cavity, the height of over burden etc. Typical schemes from actual instrumentation done at different project sites are shown in Figures 1 to 6 and Photo 2.

3.1 Power house & transformer hall cavern instrumentation

Figure 1 shows instrumentation for only one section. It consists of three point electronic bore hole extensometers, electronic centre hole load cells for rock anchors and tape convergence points. Piezometers may be mounted if required.

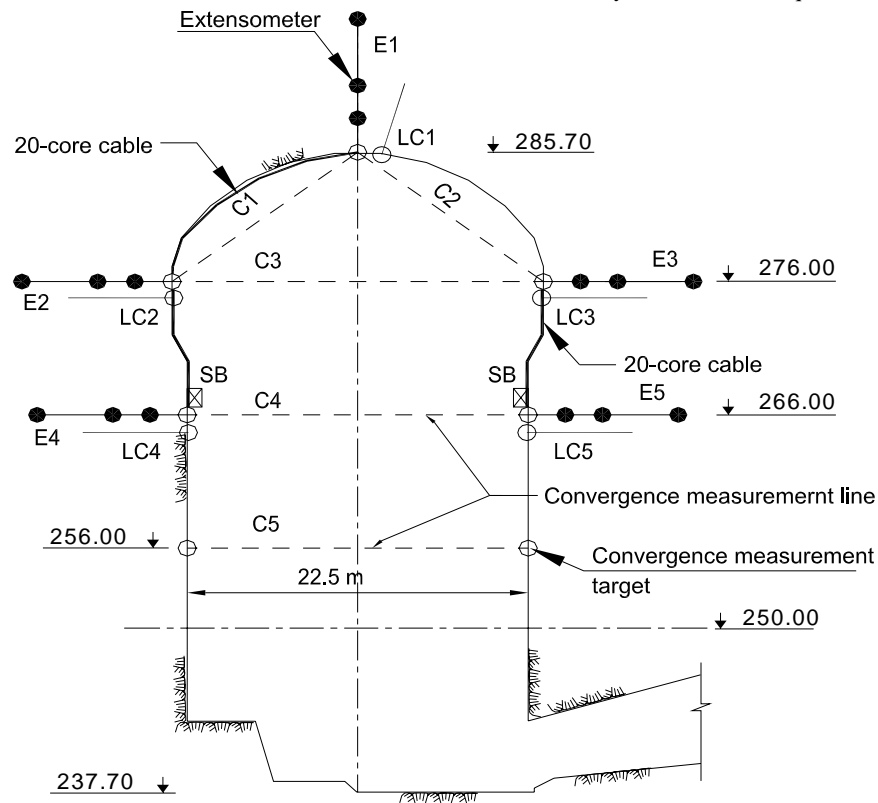

Figure 1. The instrumentation scheme shown above was repeated every about 20 m at this site

3.2 Penstock instrumentation (Fig. 2 & 3)

3.3 Road/rail tunnel instrumentation

The instrumentation requirements are more or less the same as in any underground cavity described above, except that additional instrumentation is required for the steel ribs or NATM shotcrete as the case may be.

For steel ribs, compressive load cells described

under section 2.3 above and strain gages described under section 2.4 above are used. For NATM tunnels, regroutable type shotcrete-concrete cells described under section 2.6 above are used for best results. Normally shotcrete cells are used for both radial and tangential stress measurements. However, for tangential stress measurements, special wide range strain gages (15,000 micro strain) described under section 2.5 are commonly used for better results (Figs. 4, 5 & 6).

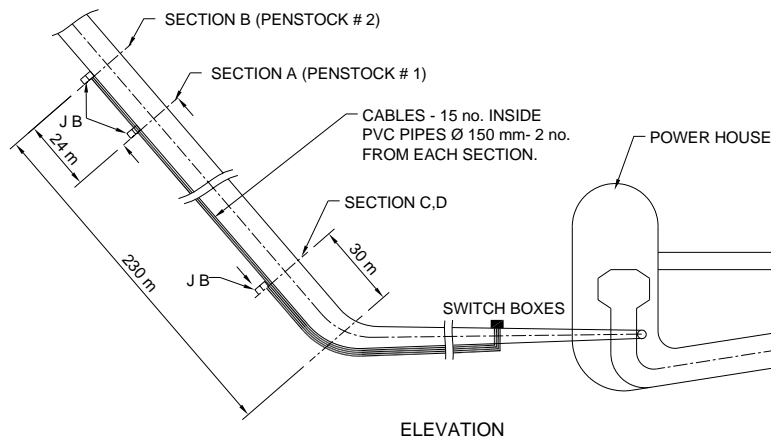

Figure 2. In the particular project, instrumentation was done in three sections (about 7 m dia) spread over a distance of 230 m

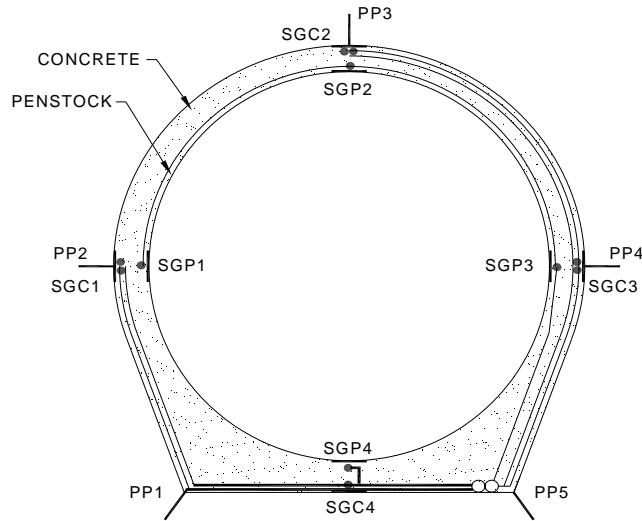

Figure 3. Each section had pore pressure meters, embedment strain gages and strain gages



Photo 2. Encardio-rite EDS 20AW strain gages welded on the penstock

Typical schemes of instrumentation for rail tunnels for Jammu Srinagar rail link project are depicted below. Some of the data obtained by the author from these types of instruments used for Jammu Srinagar rail link project has also been presented.

The following data were observed during construction of a tunnel in Jammu-Srinagar rail link project. Rock cover overburden is 923.04 m. The rock was highly jointed & fractured. Dolomite with heavy seepage of water was found during excavation. Support rib ISHB 150x150x8.4 @ 0.5 m spacing. Note the changes in load pattern shown by readings of the load cells, pressure cells & tape extensometer (Figs. 7 A & 7 B and 8 A & 8 B).

Summary of findings from data monitored above

Several tunnels were monitored and the data obtained was more or less on similar lines as the above data. The rock strata at this site was found to be very weak. The base load cells as well as pressure cells showed very much increasing stress levels. Tape extensometer readings also showed increased convergence. Based upon the instrument readings, urgent measures were undertaken to

strengthen the rock strata and the progress of excavation had to be slowed down.

4. MONITORING OF METRO RAILWAY TUNNELS

4.1 Construction instrumentation and monitoring

4.1.1 Instrumentation and monitoring for cut and cover station boxes and shafts

At cut and cover station boxes and shafts, instruments are installed in monitoring arrays (Figs. 9 & 10). Exact number of arrays and the spacing between them depends upon the ground conditions and design of the station box and shaft. In general the instruments used are:

- Precise levelling point (PLP) arrays are established to monitor ground movements with distance from the excavation.
- Inclinator cum magnetic extensometers are positioned close to the diaphragm wall on each side of the excavation (typically two no. are located in a monitoring array) to monitor the slurry trenching excavation for the diaphragm walls.

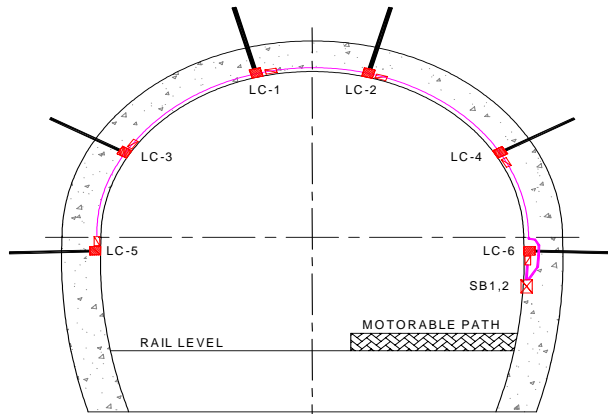

INSTRUMENTATION MONITORING CROSS SECTION
 (ONE SECTION AT EVERY ALTERNATE 500 m INTERVAL)

ABBREVIATIONS:
 LC ROCK BOLT LOAD CELL, 25 tf.

Figure 4. In this particular project, to monitor tension in the rock bolts, five centre hole load cells of 250 kN capacity are used. This section is repeated at every 500 m.

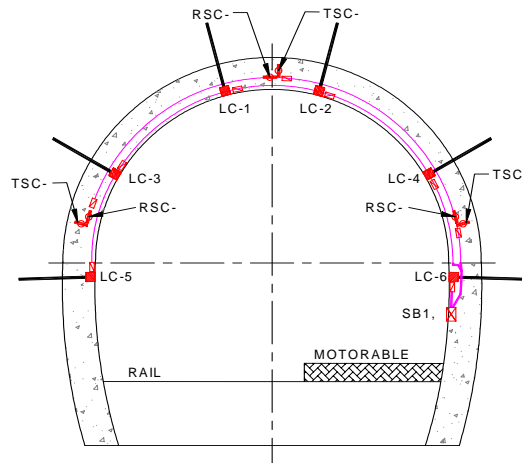

INSTRUMENTATION MONITORING CROSS
 (ONE SECTION AT EVERY 1000 m)

ABBREVIATION
 LC ROCK BOLT LOAD CELL,
 RSC SHOTCRETE / CONCRETE STRESS CELL - RADIAL,
 TSC SHOTCRETE / CONCRETE STRESS CELL - TANGENTIAL.

Figure 5. In this particular project, to monitor shotcrete stress, three pairs of shotcrete cells are used. Each pair has one 5 MPa cell for measuring radial and one 20 MPa cell for measuring tangential stress.

- Inclinator gage wells are installed in the diaphragm walls to monitor the lateral wall movement.
- Heave extensometers of either electronic type or magnetic type are installed at main monitoring arrays between the excavation support walls, where the excavation formation level is in soil.
- Earth pressure cell below the concrete base slab to measure heave pressure.

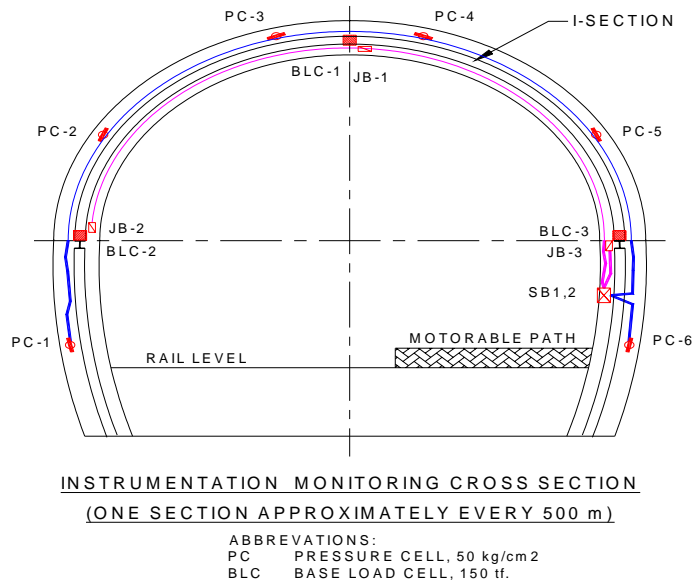

Figure 6. The section shown above, repeated every 500 m, has three compression (base) load cells of 1500 kN capacity in the I beam and six pressure cells of 5 MPa capacity in the concrete.

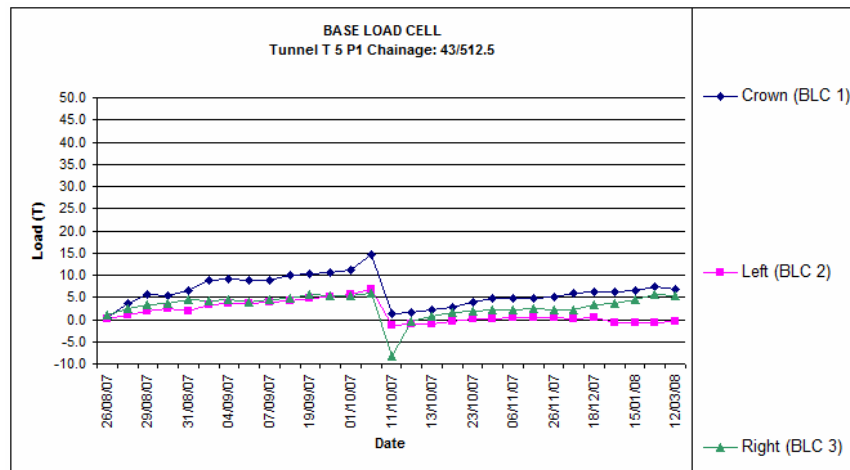

Figure 7A. Data obtained from compression (base) Load Cells in tunnel T5, portal 1

- Strain gauges with built-in temperature sensors and load cells are mounted to all levels of temporary struts at monitoring sections to monitor the strut loads. At each I beam of the struts strain gauges are equally spaced around the strut perimeter to get averaged out strain value.
- Rebar strain gauges with built-in temperature sensors are attached to the reinforcement cages

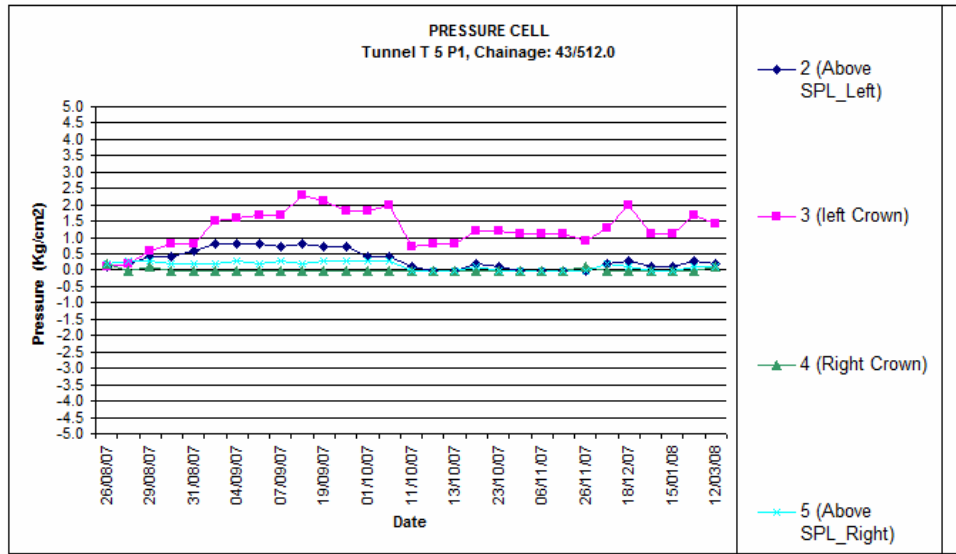

Figure 7B. Data obtained from Pressure Cells at the same place

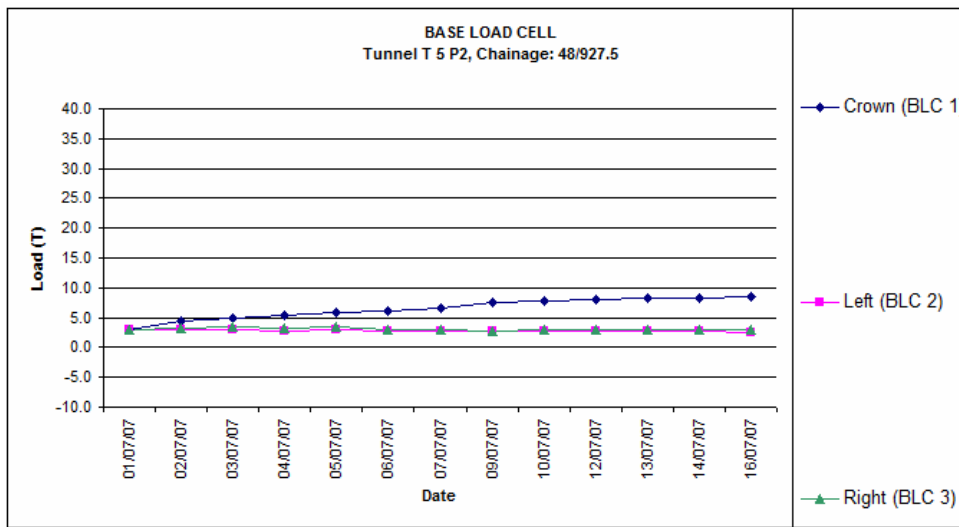

Figure 8A. Data obtained from compression (base) Load Cells in tunnel T5, portal 2

of two opposing diaphragm wall panels at monitoring test sections (Photo 3).

4.1.2 Instrumentation and monitoring for cut and cover tunnel sections

The cut and cover tunnel sections are monitored in much the same manner as described above for the station boxes see Figure 10.

4.1.3 Instrumentation and monitoring for bored tunnel sections

Monitoring along the alignment of bored tunnel sections (Fig 12) are undertaken by a combination of inclinometers, magnetic extensometers and precise levelling point arrays (Fig. 11).

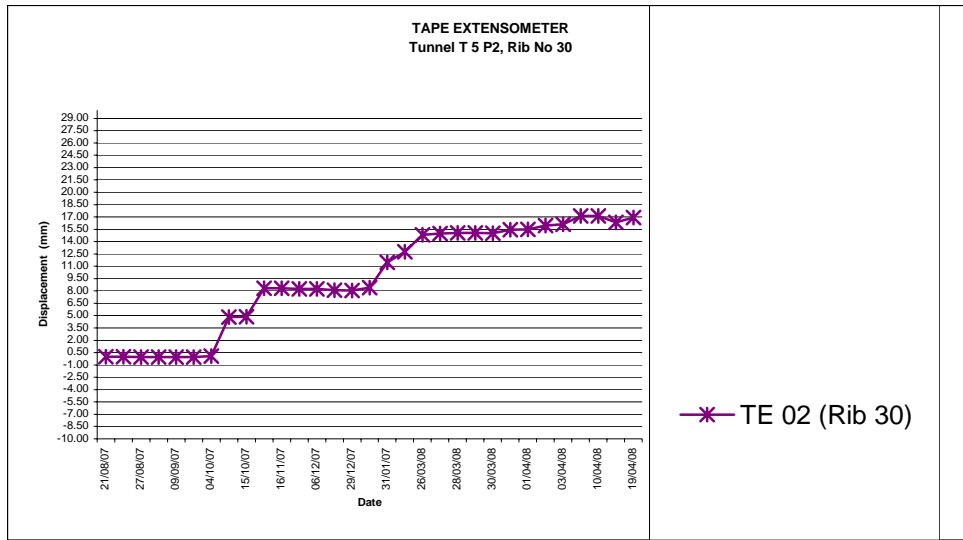

Figure 8B. Data obtained from Tape Extensometers at the same place. Immediate corrective actions were taken following this abnormal convergence.

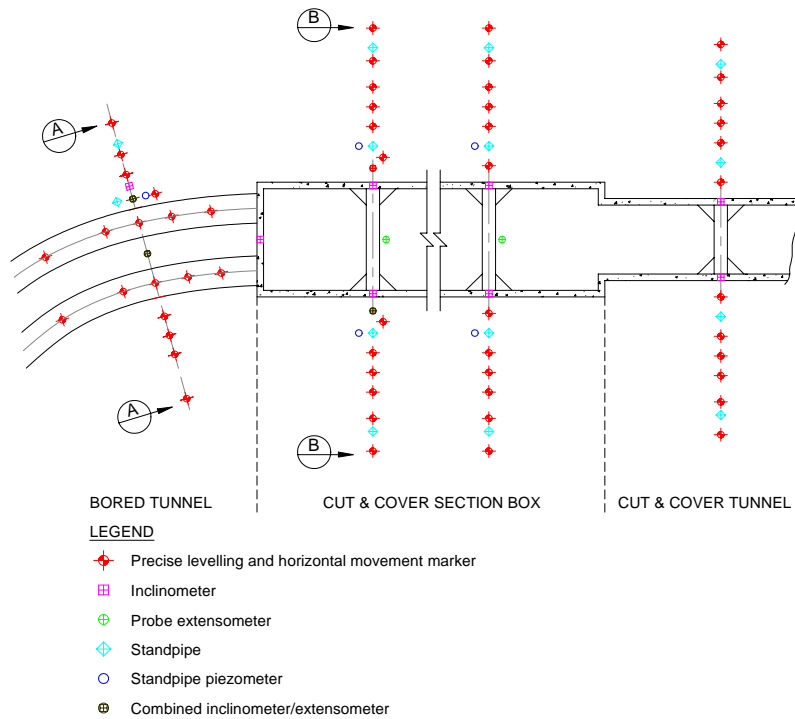

Figure 9. Typical monitoring for bored tunnel, cut & cover station box/tunnel

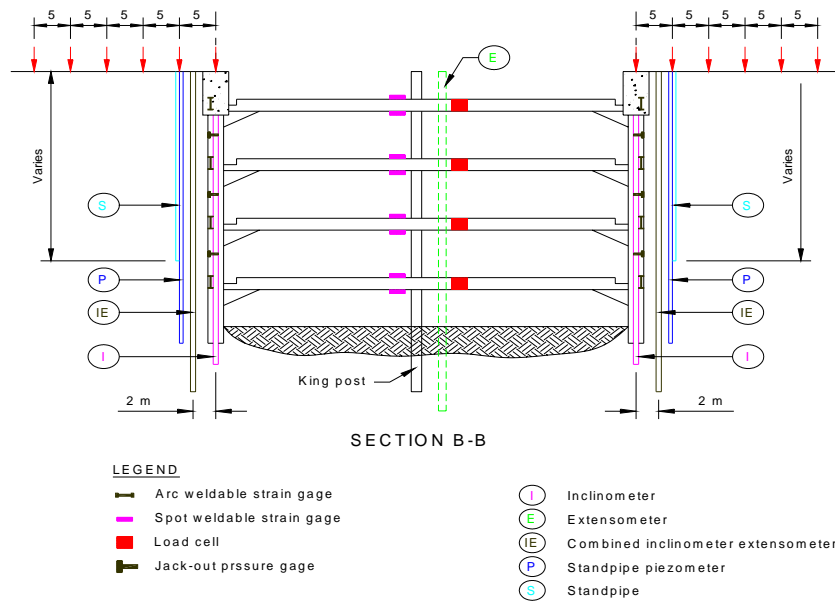

Figure 10. Typical cut and cover station box monitoring section. The distances are those used in this particular site and may vary for others depending upon specific site conditions



Photo 3. GI casing welded to a reinforcement cage of a diaphragm (D) wall

4.1.4 Monitoring of NATM tunnels

Various monitoring devices are installed in monitoring sections in a NATM tunnel have already been covered under Road/rail tunnel instrumentation earlier in this paper.

4.2 Groundwater monitoring

For carrying out groundwater monitoring, standpipe and Casagrande piezometers or Electronic piezometers are installed in the ground at strategic locations along the route.

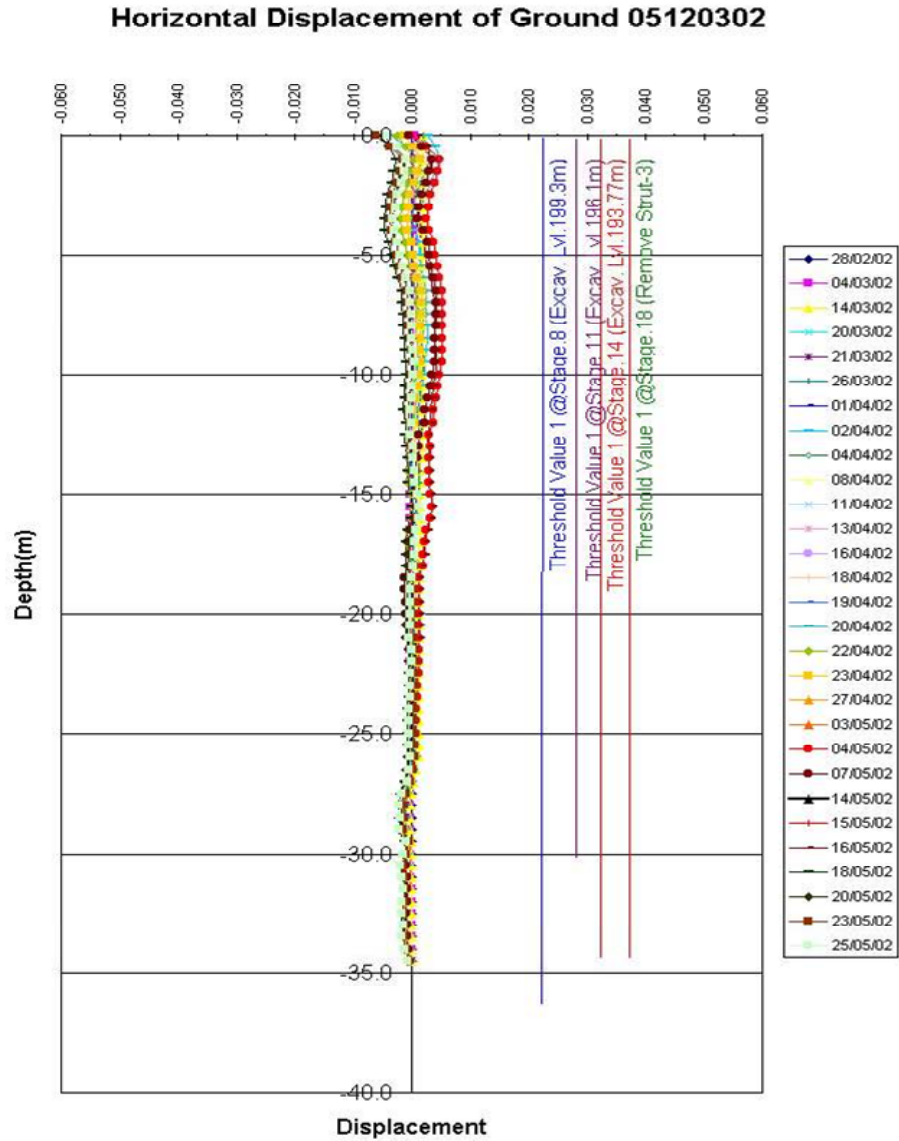

Figure 11. Typical inclinometer data inside D wall

4.3 Existing building and utility monitoring

These are monitored by means of Precise levelling points, Crack gauges and Tilt meters.

4.4 Real time monitoring systems

Parameters such as tilt of important buildings, stress/strain in struts etc. are monitored in real time. The Data Acquisition System generates alarm and produces real time data on the internet.

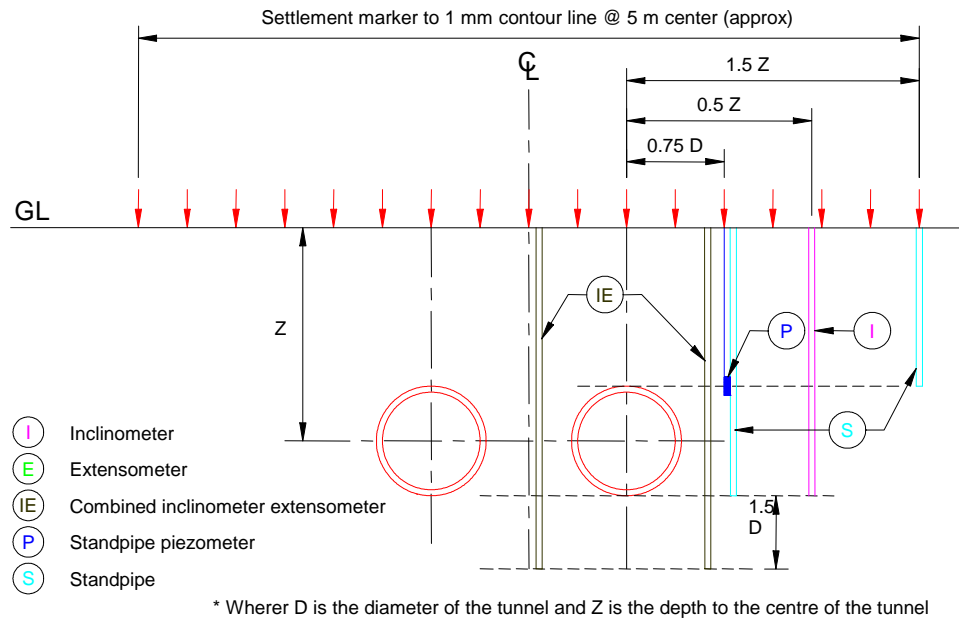

SECTION A-A

Figure 12. Typical instrumentation scheme for bored tunnel

5. CONCLUSION

The use of instrumentation is an essential part of any construction activity today. Geotechnical instrumentation is different from any other type of instruments in that it needs a comprehensive and complete interaction between the designer, the user and the instrument supplier. Proper installation of geotechnical instruments is as important as the quality of instrument itself since once embedded, the instrument cannot be taken out. If an instrument has failed after installation, it cannot be replaced. No benefit can be obtained from these instruments unless the instruments are installed properly, the data monitored regularly and made available to the user readily for example over the internet. And last but not the least, the data must be interpreted and made use of by the user at all times.

BIOGRAPHICAL DETAILS OF THE AUTHOR

V.K. Rastogi graduated in Electrical Engineering from the University of Rajasthan in 1970. From 1970 to 1979, he worked for Instrumentation Limited, Kota, specializing in system design of power plant and process instrumentation. In 1979 he joined KELTRON where he worked on the system design of thermal power plants with French instrumentation. In 1982, he joined UPTRON and started its Control Systems Division with American collaboration. Since 1993, he is working with Encardio-rite and presently as Director heading its Marketing Division. He is associated with almost every geotechnical instrumentation project for dams, tunnels and metro railways in India.