



A CASE STUDY OF INSTRUMENTATION & MONITORING PROGRAM IN AN ICONIC MIXED USE DEVELOPMENT PROJECT

Mr. Amod Gujral

Managing Director, Encardio-rite Group of Companies, A-7 Industrial Estate, Talkatora Road, Lucknow, UP-226011, India, agujral@encardio.com

Mr. Prateek Mehrotra

Vice President Technical, Encardio-rite Group of Companies, A-7 Industrial Estate, Talkatora Road, Lucknow, UP-226011, India, prateek.qatar@encardio.com

SUMMARY: In the paper, the authors present a case study of I&M program executed by their organization in an iconic project in a megacity in the Middle East. An existing road bridge dissected the project's work site. Two multi-storeyed towers with several basement levels each had to come up on both sides of the bridge. The towers were supposed to be linked by a sky bridge. Safety of the existing bridge located in the middle of the deep excavations during the construction stage was on the top priority with all project stakeholders as well as the assets' owners. The paper starts off with a brief overview of the project with salient features of the construction methodology deployed, followed by the description of instrumentation & monitoring scheme implemented for the project. Details of key parameters monitored and the type of instruments selected for the purpose have also been described. Challenges faced during the installation campaigns in the bridge and around the deep excavations and how these were met with practical solutions are mentioned in the subsequent section. Description of the setup of automated data collection, its transmission and online presentation follow. Fast processing of the collected data, its lucid presentation for easy assimilation and its instant access-not restricted by geographical boundaries- is the key feature of a successful I&M programme. This aspect is covered in the next section along with a summary of the observed data. Key conclusions drawn from the instrumentation programme and lessons learned, sum up the paper.

KEYWORDS: Online monitoring, deep excavation instrumentation & monitoring, automatic data collection

1 INTRODUCTION

This paper describes the instrumentation and monitoring programmed undertaken by the authors' organization in a landmark project in the Middle East. The project comprised of two towers-tower A and tower B on either side of an existing road bridge, which passed through the centre of the plot. Tower A was mixed-use with residential and commercial spaces and a hotel with 66 levels and a total height of 305 m. Tower B was a 240 m tall structure with 56 levels comprising of residential

apartments. The Podium of the towers had 3 levels and the basement comprised of 7 levels for the car park. The excavation levels for construction of the basement ranged from 23.8 to 25 m below the existing ground level. The two towers were linked together by a 225 m long sky bridge which cantilevered 70 m beyond tower A.

Additionally, the basements of the two towers were connected with two tunnels located underneath the existing bridge. Excavation to a depth of 9 m below the existing ground level was required for the tunnels

For mitigating the risk of damage to any existing assets within and outside of the construction boundaries a comprehensive instrumentation and monitoring programme was planned by the designers.

2 MONITORING REQUIREMENTS

Monitoring requirements worked out by the project designers comprised of the following:

1. Inclinometers and optical targets on the shoring walls to monitor lateral and vertical deflections of shoring wall due to excavation
2. 3D targets on bridge piers and at mid-span to monitor the bridge movements in horizontal and vertical planes
3. Strain gages on the bridge segments above the piers and at mid-span to monitor the stresses developing in the bridge due to excavation and dewatering works
4. Ambient temperature on top, bottom and sides of the bridge deck to correlate the monitoring data with the ambient temperature changes
5. Groundwater monitoring within the dewatering wells and outside the excavation through standpipe piezometers

Refer to **Figure 1** for instrumentation layout plan of the project.

In the following sections, a detailed description of the monitoring of the most critical structure of the project i.e. the bridge, using 3D targets, strain gages and temperature sensors is given:

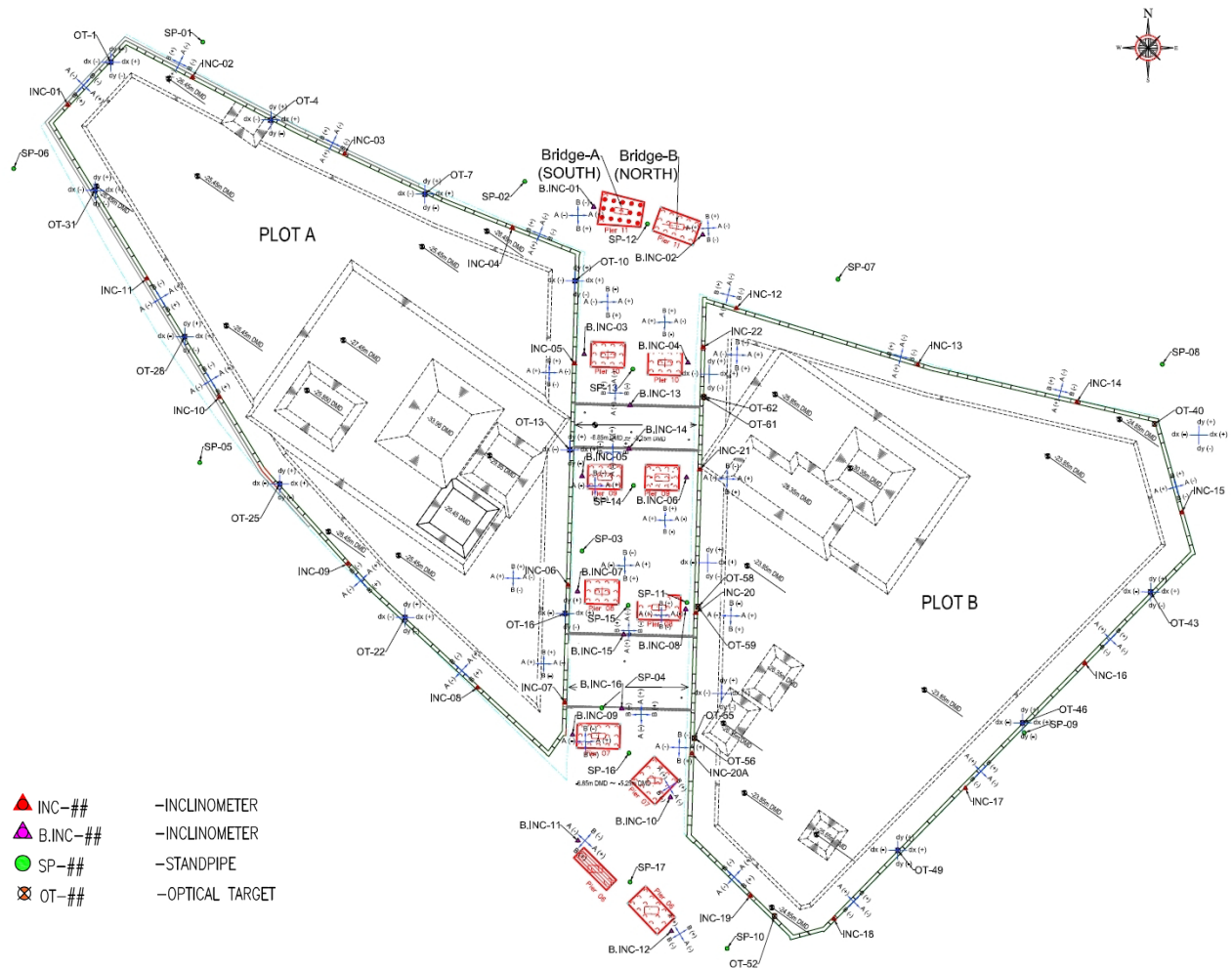

Figure 1: Instrumentation layout plan

3. AUTOMATIC 3D DEFORMATION MONITORING SYSTEM

The automatic 3D deformation monitoring system used for the measurements of the bridge piers comprised of automatic total stations (ATS) controlled by dedicated control boxes (Figure 2) and a monitoring database management software installed on a central server.

The control box included a preprogrammed software that controlled the ATS. This software-operated the ATS and scheduled the frequency of the measurements, the filters of acceptance or repetition of each measurement, the calculation and repositioning of the total station etc.

For locations of the 3 no. automatic total station used in the project, refer to Figure 3. The ATS measured prism targets installed on both sides of the piers and at the mid-span on each bridge. Each ATS had a dedicated number of prisms of measurements. The frequency of the automatic measurement was programmed as 20 minutes.

For the location of prism targets on each of the 12 no. bridge piers monitored please refer to Figure 4. Targets were also installed at the mid-spans of the bridge.

After completion of each monitoring cycle, the raw data was transmitted to the central server with the monitoring data software over the cellular network. The software then processed the data and results were

inputted the spreadsheet.

The above-mentioned system ensured timely monitoring of the displacements, providing 20 minutes measurements, simultaneous wireless transmission of the results and entry into the MDB system to ensure the minimal time between their reading and their evaluation and short time period for rechecking the obtained results when needed.

3.1 Geodetic Network Setup

A network of reference prisms was established around the site in order to provide orientation to the ATSS. The positions of the reference points were chosen considering the following:

- All of the prisms are located outside the construction area
- The prisms are shared between the ATSS.

The reference prisms were positioned on small concrete pillars specifically constructed for the project and also on the existing structures located outside the zone of influence of the construction.

3.2 Automatic Total Station

Each ATS was positioned on a 3 metallic pillar specially fabricated for the project (**Figure 2**). These were installed outside the influence zone as far as possible, still not too far away from the bridge elements which need to be monitored. Positions of the ATS were determined after the site inspections in such manner that a clear visibility is obtained for all installed monitoring and reference prisms and with minimal vibration from the construction activities.



Figure 2: Installed ATS on site with control box and solar panel power supply

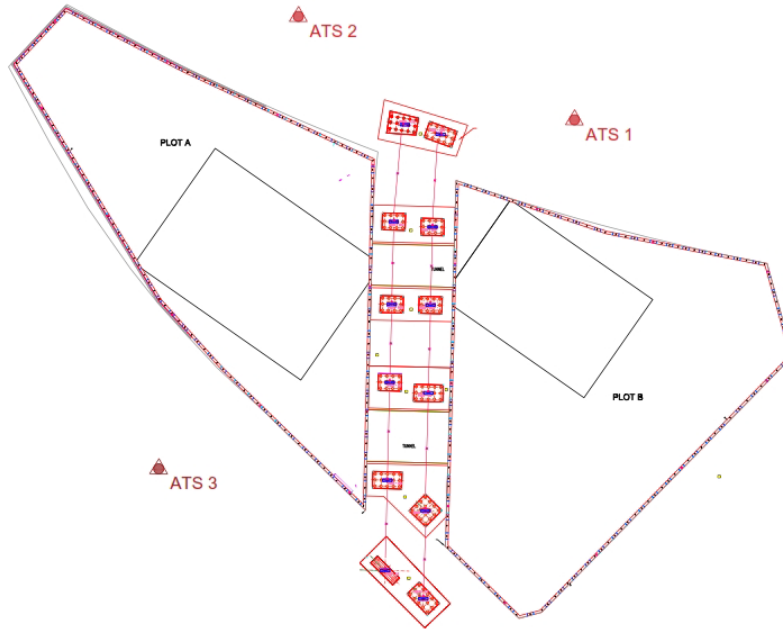

Figure 3: Sketch of the location of the ATS

3.3 Installation of optical targets

Monitoring prisms were installed on each of the 12 piers of the bridge, as per **Figure 4**, as well as the midspan between piers according to the visibility from the ATS locations and surrounding activities. This setup ensured that the bridge was monitored from both sides.

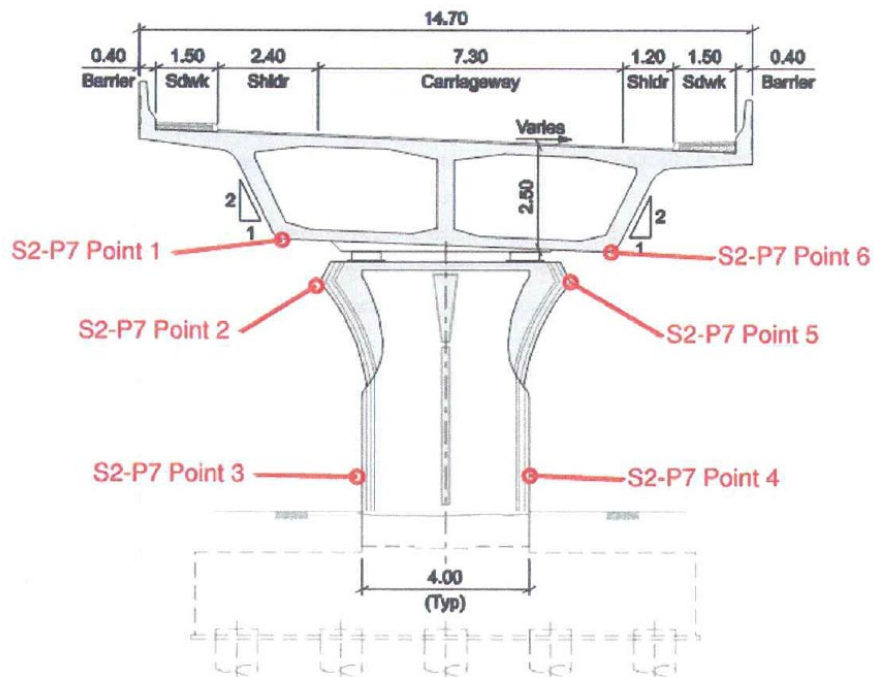

Figure 4: Configuration of the optical targets

3.3 Measurements, processing & reporting

The process implemented can be described as Automatic Monitoring System with Human Interface for Evaluating Data (AMS-HIED). Workflow of the entire process is performed in following steps:

3.3.1 Upload of measurements to the monitoring database

After upload of the raw measurements in the database after each 20 min cycle, the software automatically applied the following filters in order to minimize the noise:

3.3.2 Applying the filter for random error cap

Random error is an error which comes accidentally as an unpredicted event and effects the measurement in a way that amplifies the results in very large scale. Examples of the random errors are disturbance in the line of sight causing the laser beam from the ATS to travel longer time than in normal case and as a result to produce the bigger distance and consequently wrong coordinates of the optical target; reflections from the mirrors of the moving vehicles; physical influence to the monitoring post etc.

Random error cap was incorporated into the system with the purpose of automatic recognition and deactivation of those values which are affected by this error. This cap stops the unrealistic high values (which are beyond any possible movement) which could create a false alarm from entering into the alert system. The readings still remained in the monitoring database.

Applying the cap for random error is done automatically (automatic recognition and deactivation) on all collected data. All values falling outside the predefined cap by the administrator e.g. $R = \pm 2.5$ cm. were deactivated. The cap value was subject to re-evaluation in case of real settlement of this magnitude.

3.3.3 Applying moving average filter:

The moving average filter reduces random noise while retaining a sharp step response. **Figure 5**

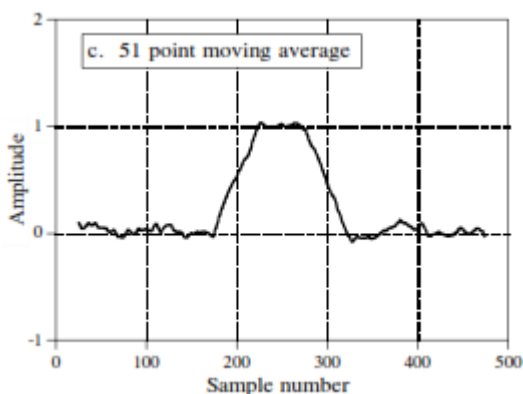

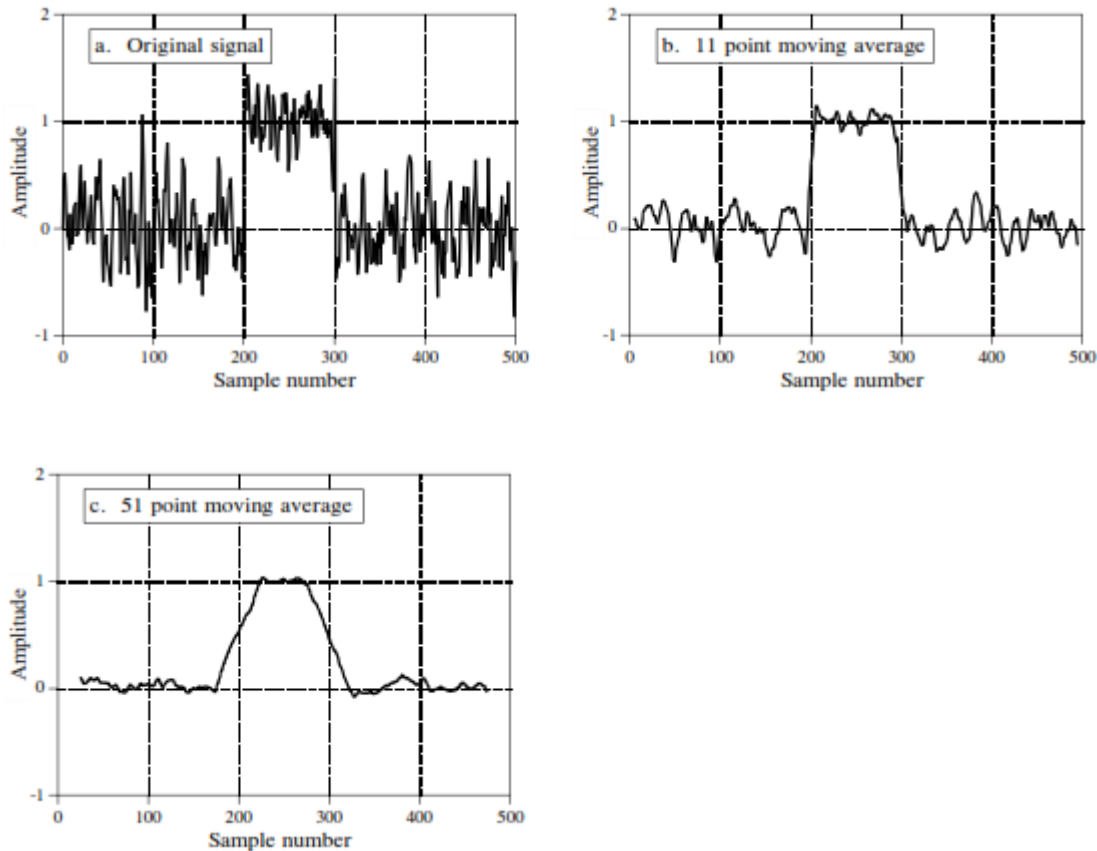

Figure 5: Moving average filter

The measurements in (a) have been weighed down with random noise. In (b) and (c), the smoothing action of the moving average filter decreases the amplitude of the random noise and also reduces the sharpness of the edges. Of all the possible linear filters that could be used, the moving average produces the lowest noise for a given edge sharpness.

Given a series of numbers and a fixed subset size, the first element of the moving average is obtained by taking the average of the initially fixed subset of the number series. Then the subset is modified by "shifting forward"; that is, excluding the first number of the series and including the next number following the original subset in the series. This creates a new subset of numbers, which is averaged. This process is repeated over the entire data series. The plotline connecting all the (fixed) averages is the moving average. A moving average is a set of numbers, each of which is the average of the corresponding subset of a larger set of datum points.

$$y[i] = \frac{1}{M} \sum_{j=0}^{M-1} x[i+j]$$

(1)

Where, x-Input measurement, y-output values for the period, M-moving average factor (number representing the value of the dataset length)

For the project described in the paper, the moving average filter was determined on the basis of number of measurements in one day, Same factor was applied to the each of the 3 values, DHTX (lateral movement along the bridge alignment), DDCL (lateral movement perpendicular to the

bridge alignment) and DZ (vertical displacement). Values calculated using the moving average filter were used for representing the curves of the trend lines.

3.3.4 Automatic input to Tony Gee report

An Excel spreadsheet was developed by bridge designer-Tony Gee report, in which differential settlements and lateral movement of the bridge were taken into account. Pier movements were checked against the actual design capacity of the bridge deck section.

A modification to the original database software was applied in order to:

- Automatically input the results in the spreadsheet
- Automatic reading of the results and automatic notification in case of alarm (SMS and emails)
- Upload the report to web cloud under the 20 minutes reporting regime

Automatic preparation of the data for input into the spreadsheet (averaging the values of prisms on the same level from both sides of the piers) was done by the database software. For each pier, 4 prisms were taken into account for the analysis. Two prisms on the top of the pier, two prisms on the bottom of the pier (refer to **Figure 6**) as described below:

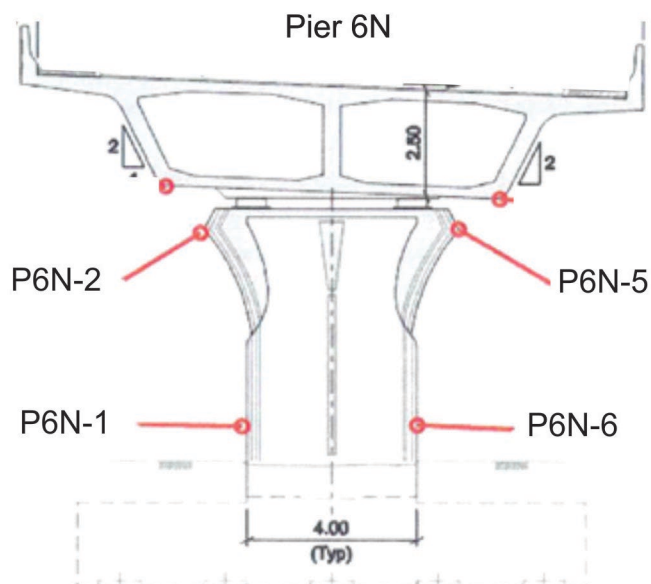

Figure 6: Schematic view of the used prisms for the Tony Gee spreadsheet

- a. From two prisms on top of the pier (prism P6N-2 and prism P6N-5), the software used the readings representing the lateral movement to the bridge (DDCL) average these and stored in the correspondent cell for TOP SURVEY POINT VALUES AVERAGE (refer to **Figure 7**)
- b. From two prisms on bottom of the pier (prism P6N-1 and prism P6N-6), the software used the readings for lateral movement to the bridge (DDCL), average these and stored in the correspondent cell for BOTTOM SURVEY POINT VALUES AVERAGE (refer to **Figure 7**)
- c. From two prisms on bottom of the pier (prism P6N-1 and prism P6N-6), the software used the readings for vertical movement (DZ), averaged the values and stored in the correspondent cell for VERTICAL DISPLACEMENT AVERAGE (refer to **Figure 7**)

Survey Point Record Sheet										Name of Surveyor:
Bridges N2 and N3										Date:
SURVEY INPUTS										
Top Survey Point Values average- LATERAL										
P6	P7	P8	P9a	P9b	P10	P11	P12	P13	P14	mm
-0.3	-0.7	0.5	0.5	0.5	-0.9	-0.3	0	0	0	
Average value of prisms P6N-2 and P6N-5 for lateral movement to bridge										
Bottom Survey Point Values average- LATERAL										
P6	P7	P8	P9a	P9b	P10	P11	P12	P13	P14	mm
0.1	-0.2	-1.5	0.7	0.7	-0.2	-0.1	0	0	0	
Average value of prisms P6N-1 and P6N-6 for lateral movement to bridge										
Vertical displacement average										
P6	P7	P8	P9a	P9b	P10	P11	P12	P13	P14	mm
-0.6	0.3	0.0	-0.6	-0.6	0.3	0.9	0	0	0	
Average value of prisms P6N-1 and P6N-6 for vertical movement bridge										

Figure 7: Tony Gee spreadsheet and input of values

The system automatically compared the results imputed into the Tony Gee spreadsheet to trigger values and provided the following alarms states (**Figure 8**):

RESULTS											
Lateral Bearing Capacity Result											
P6	P7	P8	P9a	P9b	P10	P11	P12	P13	P14		
OK	OK	OK	OK	OK	OK	OK	OK	OK	OK		
Vertical Bearing Capacity Result											
P6	P7	P8	P9a	P9b	P10	P11	P12	P13	P14		
OK	OK	OK	OK	OK	OK	OK	OK	OK	OK		
Pier Rotation Check											
P6	P7	P8	P9	P10	P11	P12	P13	P14			
OK	OK	OK	OK	OK	OK	OK	OK	OK			
Max Deck Stresses S2				Max Deck Stresses S3							
Point 1	Point 2	Point 3	Point 4	Point 1	Point 2	Point 3	Point 4				
-1.62E+00	1.64E+00	1.29E+00	1.00E+00	-5.20E-01	1.71E-01	2.35E+00	2.52E+00				
OK	OK	OK	OK	OK	OK	OK	OK				

Figure 8: Alert status from the Tony Gee spreadsheet results

- GREEN STATE: System confirmed that results are “OK”, the report generated and uploaded to the web cloud.
- ORANGE STATE: System is confirmed “Action” or “Overloaded” condition and alarm were sent to all parties according to the communication protocol. The Monitoring Engineer took the following actions to confirm readings for the affected prisms:
 - Reconfigured the ATS for the affected pier to ensure that all affected optical targets were monitored within the 15-20 minutes span, it allowed the system to have multiple readings which were used for confirmation of the results from the Tony Gee spreadsheet
 - Manual crosscheck of the values: Manual crosscheck of the settlement was performed for verification of the readings from the ATS. Settlement was

- measured on the installed settlement markers on the opposite side of each pier and compared with the baseline values taken previously
- Evaluation of the manual crosscheck data: The Monitoring Engineer evaluated data from the manual crosscheck and repeated the spreadsheet input with the newly acquired data from the ATS:
 - Case 1: If it turned out to be “OK” state then GREEN STATE of alarm is announced and the process continued. The report was generated and sent to all concerned parties, for the false alarm and reflected in the weekly report and an incident report was generated.
 - Case 2: In case of confirmation of the values, the system automatically sent a notification to everybody in the action list.

4. STRAIN & TEMPERATURE MEASUREMENTS

Vibrating wire type strain gages were used to measure the change in strain of the bridge’s structure owing to the construction activities. Change in stress was obtained by multiplying the measured change in strain by the modulus of elasticity of concrete. The strain gages were installed at 10 sections of the bridge and at each section one strain gauge was installed at the roof, one at the base and one each at the side walls. For the location of the strain gages (SG) along with thermistor type temperature sensors (TH) at one of the bridge sections refer to Figure 9 below:

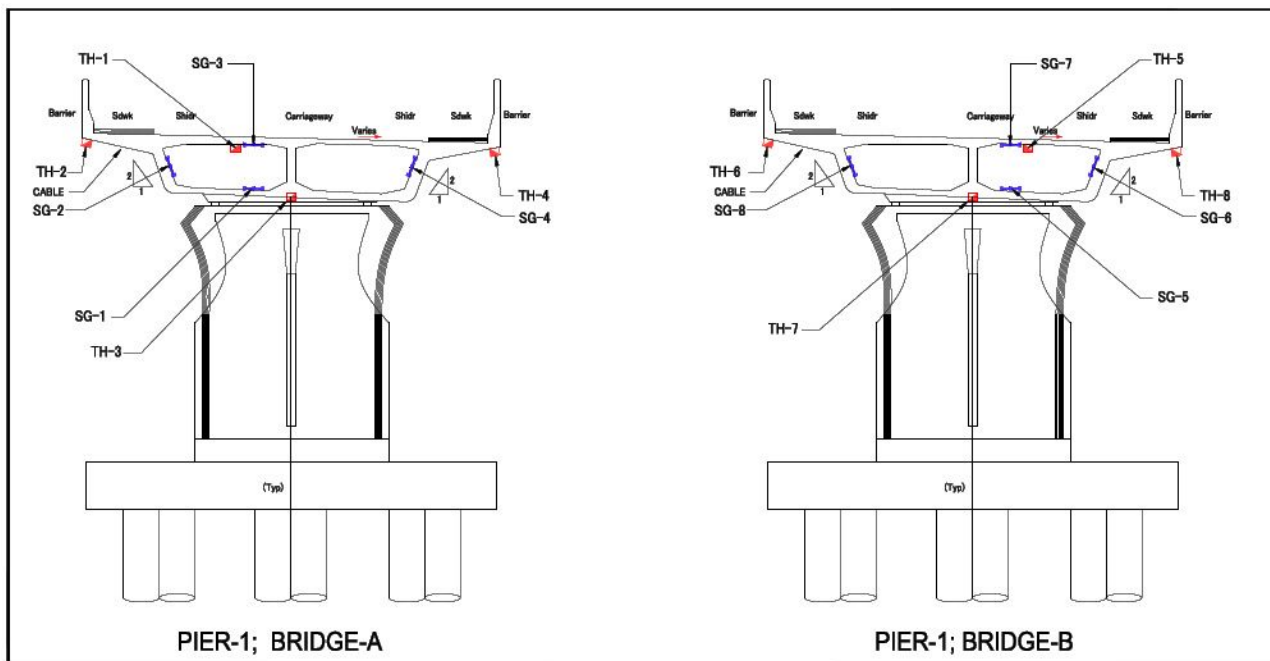

Figure 9: Strain gage and temperature sensor layout plan

In total 40 no. of strain gauges and 48 no. temperature sensors were installed on the bridge. The data from the strain gauges and temperature sensors was logged automatically every 15 minutes per day. The data was transmitted over the cellular network to a central server. The data was processed and hosted on the website created for this project. Username and password for the website was made available to all stakeholders of the project.

The initial reading of the installed strain gauges was taken as zero and changes have been monitored since then. Change with ‘+’ sign indicated tensile strain and that with ‘-’ sign indicated compressive strain.

The general trend of the strain gage data indicated a cyclic change with strain increasing to a maximum in the peak summer months and decrease winters approached.

4.1 Correction applied to the strain gauge data

Temperature variations during the day and over the year in various seasons, the effect of solar radiations during the day, variations in traffic load, creep and wind effects results in a change in stress in the structure of the bridge. This affected the readings of the strain gauges installed in the bridge. Refer to graphs of one of the strain gauges SG-1 installed in the bridge given in **Figure 10** below:

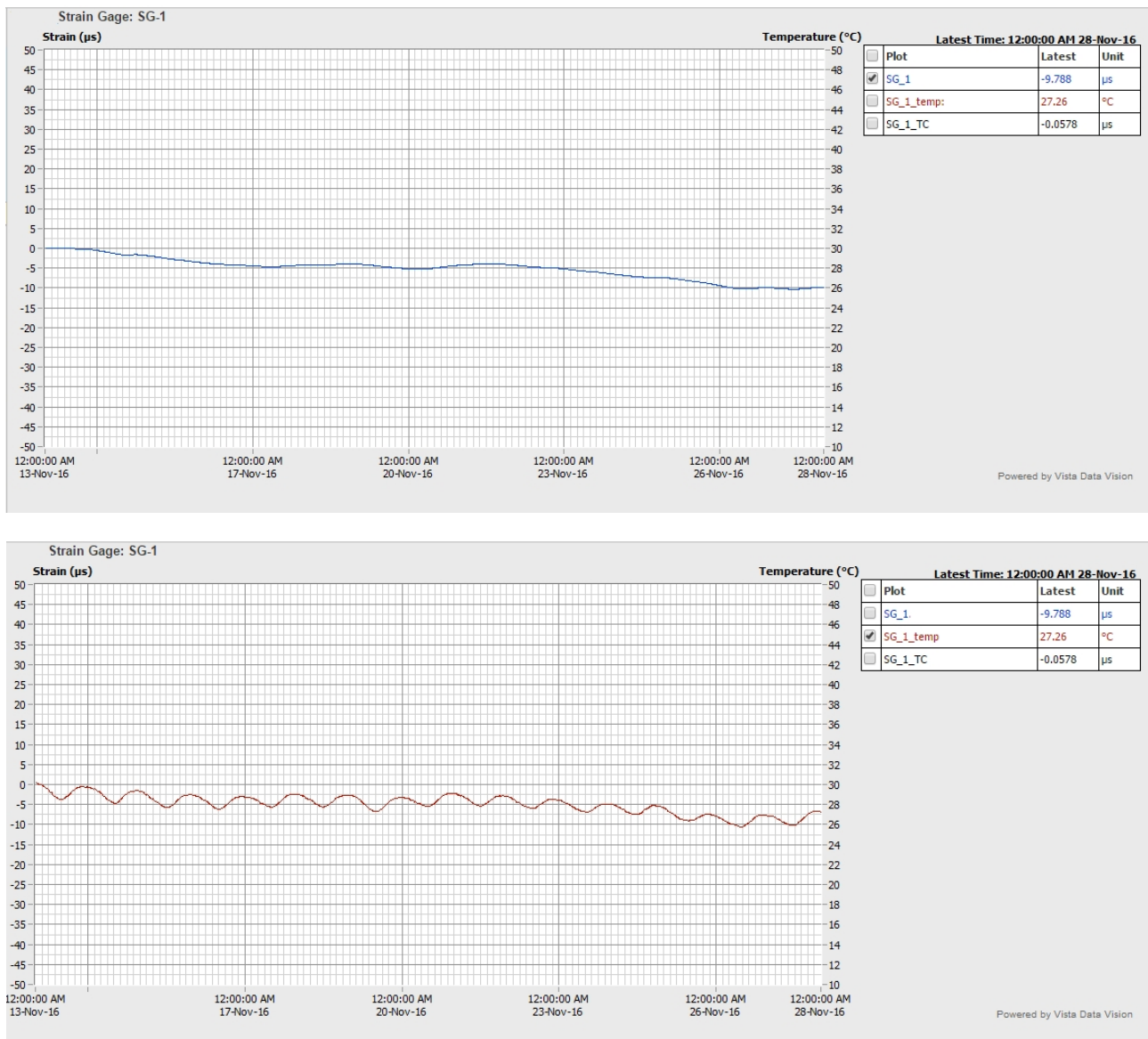

Figure 10: Strain (above) and temperature (below) graphs of strain gage SG-1

The strain gage showed a temperature variation of 4.4 deg, C during the period of November 13 to November 27, 2016. During this period the change in strain reading was 10 micro strain. For online display of the strain reading, a correction of 10 micro strains per 4.4 deg. C was made. Refer to Figure 11 for the graph of temperature-corrected data the strain gage:

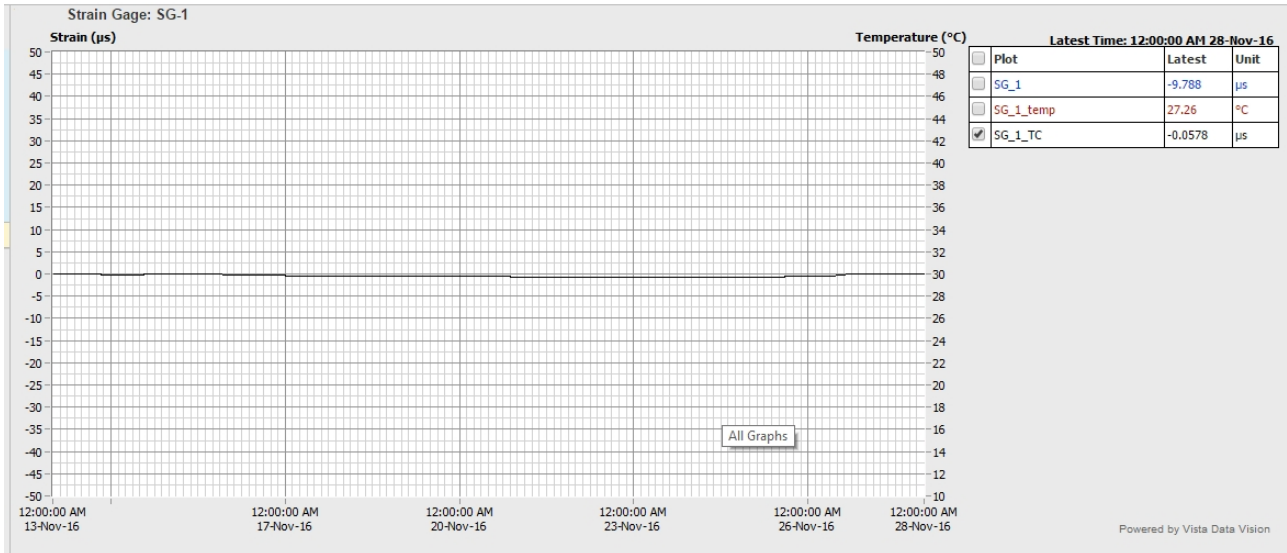

Figure 11: Temperature corrected graph of longitudinally installed strain gage SG-1

The same procedure was followed for correcting the data of all strain gauges mounted in the bridge.

For analysis purpose it is to be noted that strain gages did not measure the actual strain/stress in the structure; these measured only the values of change in strain/stress from the date of their installation. The structure of the bridge is already stressed in compression at some locations and in tension in others. This change in strain/stress is, therefore, an addition/subtraction of the strain/stress existing in the structure at the time the strain gages are installed.

5. DATA PRESENTATION

For 3D deformation measurements, reporting of the Tony Gee spreadsheet comprising of differential settlements and lateral movement of the bridge and its comparison with the designed values was done every 20 minutes. The sheets were stored on the cloud and username and password was distributed to all stakeholders.

Weekly monitoring report with graphical data presentation for all instruments installed in the project including the ones manually monitored in the project i.e. inclinometers and standpipe piezometers. Examples of 3D deformation graphical data are given in Figure 12 where the horizontal axis is timescale in dates and a vertical scale is measured value in mm. Graphs of the previous week data, as well as graphs of the historical data, were included. It also comprised of site progress pictures, instrumentation layout drawings and daily and incidence reports, if any, submitted during the previous week.

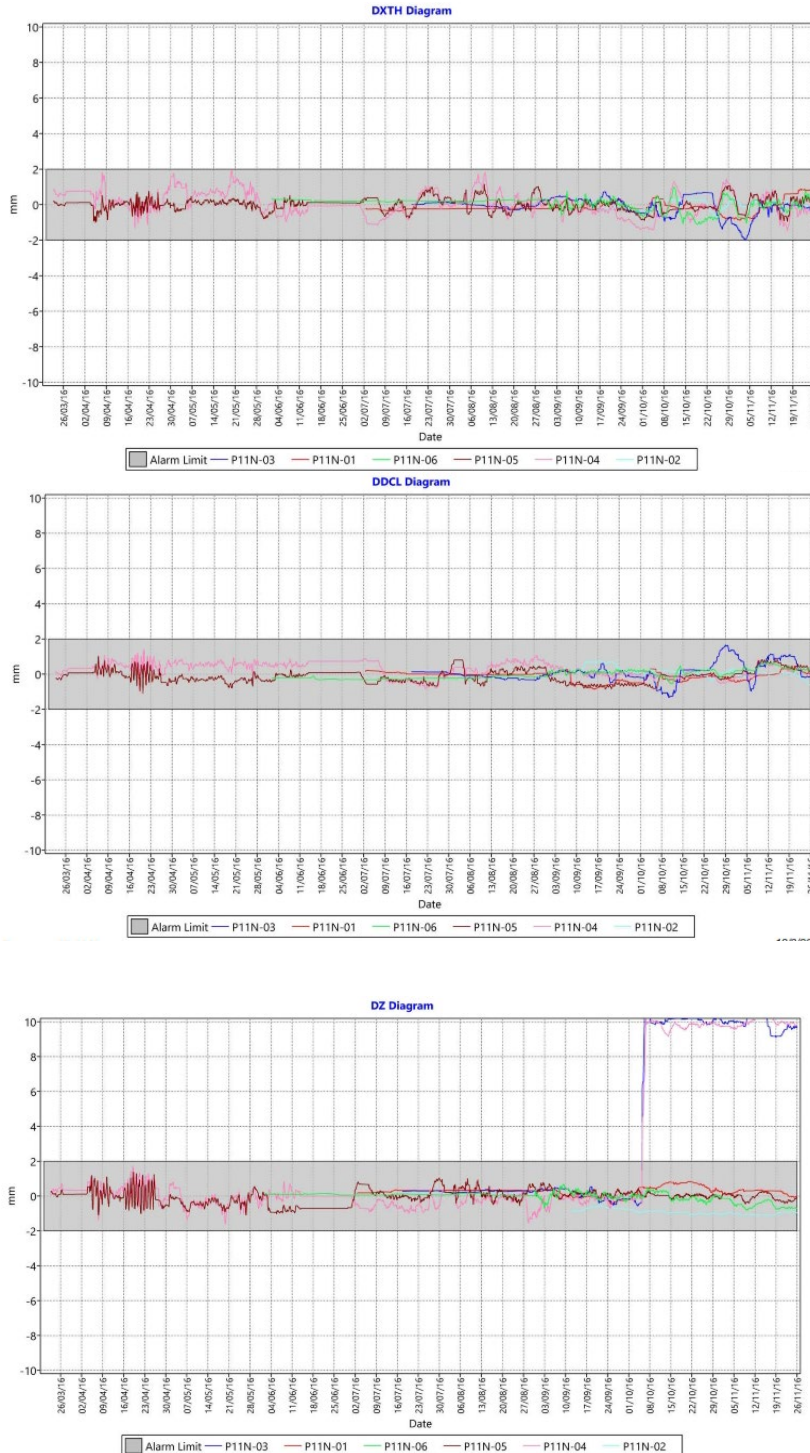

Figure 12: Example of the graph for longitudinal (top), lateral (middle) and vertical movements (bottom)

As a summary of the day, daily monitoring reports of 3D deformation data using the values from 7 AM to 7 PM from the automatic monitoring were submitted.

6. CHALLENGES FACED

- Vibrating wire strain gages and temperature sensors were installed inside the bridge deck in confined spaces. No artificial sources of lighting were used only natural light coming from the service openings, which was just sufficient, was used during the work.

- Damages and obstructions to shoring instruments due to ongoing site construction activities.
- Power outages for the datalogger for strain gage and temperature sensors were encountered resulting in a few incidences of missed data. Diesel generator sets located at the site was the main source of power for the datalogger. Sudden power surges were also encountered. Subsequently, for powering up the monitoring system the generator sets were replaced with solar power systems with 3 days autonomy. An autonomy of 3 days was selected in view of the of and mist encountered during the winters to ensure unhindered data collection and transmission during the critical stages of construction.
- Access to the bridge decks for installation and maintenance purposes depended on the availability of man lift from the main contractor. Hence it had to be planned in advance.
- Prism targets had to be cleaned regularly as these were located in a construction site.

7. CROSS-CHECKING OF 3D DEFORMATION DATA

As per the directives of the main contractor, the bridge was jacked up at the mid-span to achieve a vertically upwards displacement of 10 mm. Readings of 3D prism automatically collected by the ATS showed a movement close to the above value (**Figure 12**, bottom). The exercise proved the sound functioning of the measurement system implemented.

8. CONCLUSIONS

The monitoring system implemented at the critical construction site located at the heart of a major metropolis, helped in reducing risks, protecting existing assets and giving confidence to the construction process. Monitoring data was made available to all stakeholders seamlessly almost in the real time. This was possible with a combination of rugged sensors, advanced data collection and telemetry using the GSM network and web-based data monitoring service. Looking at the behaviour of the strain readings caused by daily and seasonal temperature changes, it is highly recommended to have a minimum of 1 year of baseline data covering all seasons. This will go a long way in filtering temperature-related changes and determining those caused by the construction activities. Perseverance of the installation and monitoring personnel is also vital for successful execution such complex projects.

REFERENCES

Dunncliff, J. (1993). *Geotechnical Instrumentation for Monitoring Field Performance*, John Wiley and Sons, New York, NY, USA. 577p.