CASE STUDY

High rise building Instrumentation & monitoring during construction



INTRODUCTION

This article presents the necessity of geotechnical instruments for monitoring high rise buildings during construction works. The iconic structure discussed in this article consisted of two towers (A & B), connected through a link bridge at mid span. A running busy road bridge bisected the locations of the two towers. The towers also had seven level car parking in their basement, connected by two tunnels, underneath the existing bridge. Thus, monitoring played a vital role in risk assessment of deep excavation, tunneling, existing road bridge, towers and link bridge. The article briefly discusses project details and monitoring instruments - where why, how, results, challenges and achievements.

PROJECT BRIEF

Tower A was ~60 m x 40 m with 300 m height above ground level and 28 m below ground level, with 76 stories. Tower B was ~55 m x 30 m with 240 m height above ground and 26 m below ground level, with 67 stories. Average floor height in both towers varied from 3.6 m to 8.5 m. Tower structure consists of center core, PT floor slabs and periphery composite columns made of steel and concrete. Both had 7 level basement parking each, connected by two tunnels.

Link Bridge was approximately 230 m in length with cantilever of 66 m projecting from tower A, spanning in the middle of the towers. Cross section of bridge was 18 m square and consisted of four levels with viewing deck and swimming pool on the roof. Link bridge connected the towers at the height of 105 m above ground level.



WHY MONITORING WAS REQUIRED?

During the construction of high rise towers and during deep excavation for basement, monitoring of construction, nearby assets, the structure - all were very critical. The monitoring instruments provided early warning, through regular or continuous monitoring, for any excessive and undue ground movements affecting the construction or nearby infrastructure. This allowed for implementation of preventive remedial actions well within time. The monitoring system helped in reduction of risks, protecting assets & construction.

Monitoring of existing road bridge

The existing road bridge (between the two towers) was monitored to observe the impact of construction activity (especially foundation works of ten two towers) being carried out adjacent to the bridge. The towers had car parks in their basements, with 7 levels, that required excavation to depths up to 25 m depth below ground level. Additionally, the basements were to be connected by two tunnels. The location of the two tunnels was underneath the existing road bridge that bisected the two towers. Excavation to a depth of 9 m below the existing ground level was required for the tunnels.

To monitor the existing road bridge, a well planned instrumentation and monitoring works was carried out for entire bridge length within the influence zone. Strain gauges, Temperature sensor, Prism targets were installed on bridges and piers at certain distance.

Monitoring during deep excavation works

This was one of the first building project in the city to have 7 basements for car park. Thus, monitoring of deep excavation was very critical. The excavation started after the completion of enabling works in which inclinometers, optical targets were installed on shoring wall to monitor the lateral movement of diaphragm wall and Piezometer were installed to ensure the water table to be maintained as per the design.

Monitoring of structure during construction

To monitor the overall building movement during tower construction, series of instrumentation and monitoring program have been adopted and implemented on most of the floors to ensure the building behavior as predicted in model study. Strain gauge, tilt sensor and prism targets were used to measure the strains which developed on columns, lateral movement & rotation of building, building movement during construction.

ENCARDIO-RITE'S ROLE

Turnkey services

- Supply of geotechnical instruments, precise survey instruments and targets
- Installation of geotechnical instruments for subsurface instruments and survey targets
- Online monitoring of critical parameters and areas
- Automatic 3D deformation monitoring
- Pre-construction condition monitoring of existing road bridge
- Programming and commissioning of data acquisition systems
- Setting up an online web-based data management system (WDMS) and maintenance during the contract period
- Daily & weekly reporting with evaluation & interpretation



INSTRUMENTS USED, LOCATION AND PURPOSE?

Monitoring requirements:

- Shoring (deep excavation) monitoring (pre-construction/during construction monitoring)
- Existing road bridge monitoring (pre-construction/during construction monitoring)
- Structure monitoring - two towers (structural movements and building tolerances)
- Link bridge monitoring (pre-construction/during construction monitoring)

Instrument	Purpose	Qty
Excavation works and ground monitoring		
Digital Inclinometer	Used to measure lateral movement due to construction activity, during deep excavation for Tower A & B at diaphragm walls, near existing bridge, near tunnel area	40 boreholes
Standpipe Piezometer	Used outside the excavation areas to determine the groundwater behavior before, during and after construction activities, near deep excavation works for Tower A & B, near existing bridge	17 boreholes
Existing bridge and pier monitoring		
Strain gages	Used on the bridge to monitor change in stresses in the bridge due to deep excavation and dewatering nearby. These were monitored every 15 minutes	40 no.
Prism Target	Used on piers of the bridge to monitor 3D movement of the bridge in order to conclude there is no structural impact on the bridge due to ongoing site activities in close vicinity.	82 no.
Temperature sensor	Used at top, bottom and sides of the bridge deck to correlate the monitoring data with the ambient temperature changes	48 no.
Structure monitoring (the two towers)		
Prism Target	Used on the Towers, every 10 floors to monitor 3D movements	
Strain gages	Used at selected columns for stress measurement and also to estimate axial shortening which experiences in load-bearing concrete columns and walls	
Tilt meter	Used on selected columns of selected floors, to monitor the horizontal displacement of structure which is an important indicator to assess structural performance and safety	
Optical Laser Plummet	To monitor the verticality of the structure	1 set
Link bridge		
Prism Target	Used at the edges at every 20 m distance along the link bridge to monitor 3D deformation	
Online data		
Automatic Dataloggers	Advanced automatic dataloggers and robotic total stations with control boxes were used collect and transmit the monitored data at required frequencies. All the monitored data (automatic and manual) was available online through our web based data management system to the Contractor, Client as well as the Consultant on their desktops.	

The excavation works started after the installation of the above instruments and recording their base readings.

DEEP EXCAVATION MONITORING



Inclinometer

Inclinometer were installed in diaphragm walls to measure lateral movement in diaphragm walls (D-wall) during deep excavation works for Tower A & B. The D-walls went more than 45 m below ground level.

As this was quite deep, first of its kind with 7 basement levels, lateral deformation of D-wall was expected during excavation and became critical for monitoring. This was also observed in some inclinometers data, where the graph represented significant lateral movement, as shown in figure 1. The variations were informed to construction team promptly. This alerted the construction team timely to take necessary preventive actions.

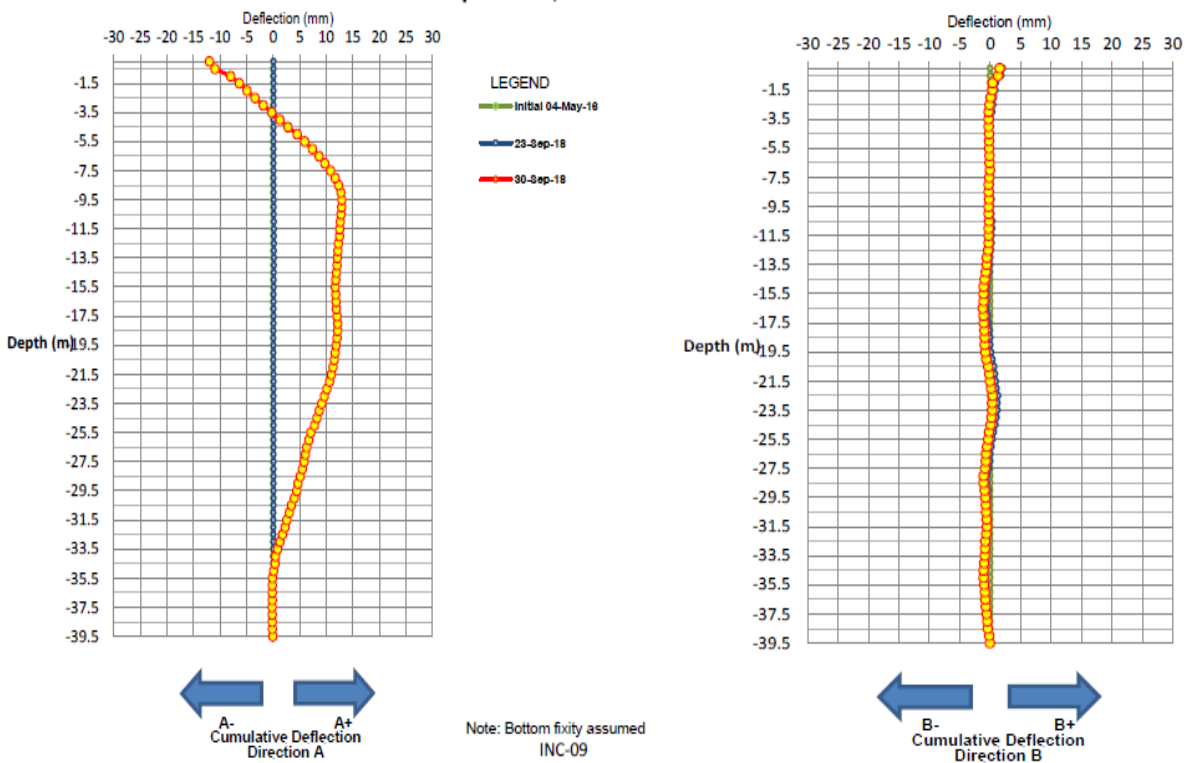

Figure 1 Inclinometer INC-09 observed movement of up to 15 mm. This alerted shoring contractor who then used anchoring to support D-walls near the bridge. The impact of anchoring was visible in our inclinometer readings, as they got stable after anchoring.

Standpipe piezometer

Standpipe piezometers were installed outside the excavation areas to determine the groundwater behaviour before, during and after construction activities. The main purpose was to have controlled dewatering which was critical to overall risk assessment.

In such deep excavations dewatering plays a vital role. One has to do controlled dewatering during excavation, to ensure that the groundwater level outside the shoring does go down below certain pre-defined levels by consultant.

Thus, it was important to monitor and inform groundwater behavior to contractor regularly to control the dewatering activity. Careful and managed dewatering prevented excessive or rapid draw down or higher than planned groundwater level

In the particular water level data from Standpipe shown below, it is seen that when dewatering was stopped, water level started to increase. On taking corrective control by contractor, it got stable.

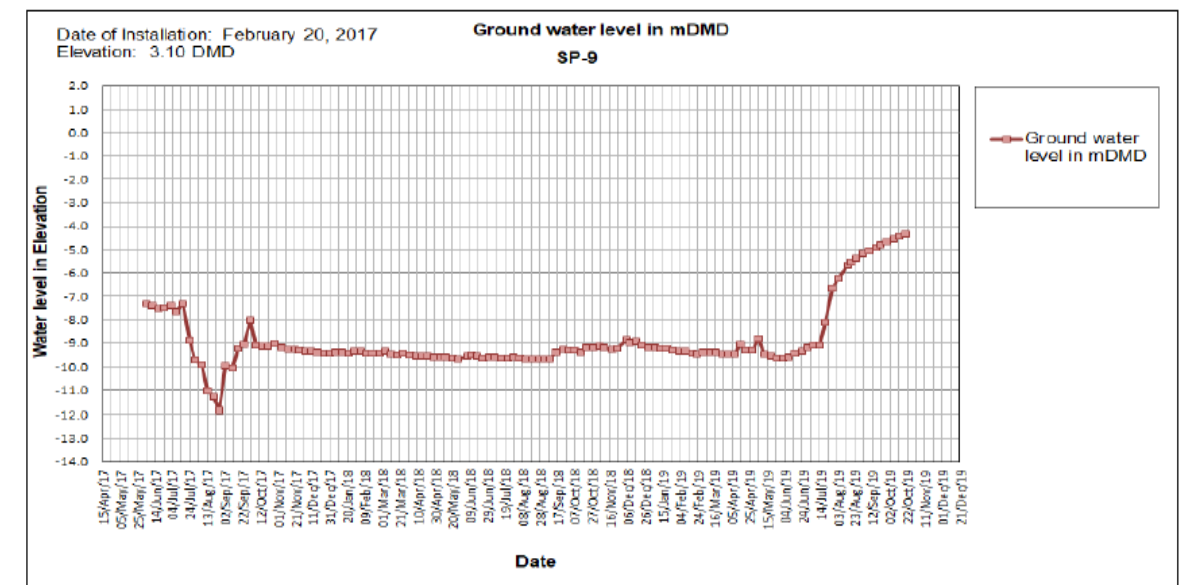

Figure 2 Ground water level data from Standpipe SP-9, showing rise in water level when dewatering stopped

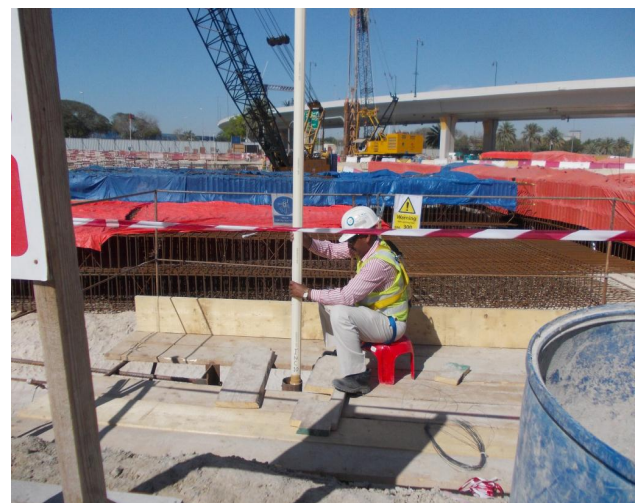

Figure 3 Standpipe piezometer (left) and inclinometer (right) being installed

BRIDGE MONITORING

Strain gage

Change in stresses were expected in the existing road bridge due to deep excavation and dewatering nearby. Vibrating wire strain gages were installed on bridge to monitor the stresses. Change in stress was obtained by multiplying the measured change in strain by the modulus of elasticity of concrete.



Figure 4 Strain gages installation on bridge

The strain gages were installed at 10 sections of the bridge. At each section, one strain gage was installed at roof, one at base and one each at the side walls. For the location of the strain gages (SG) along with thermistor type temperature sensors (TH) at one of the bridge sections, refer to figure 5.

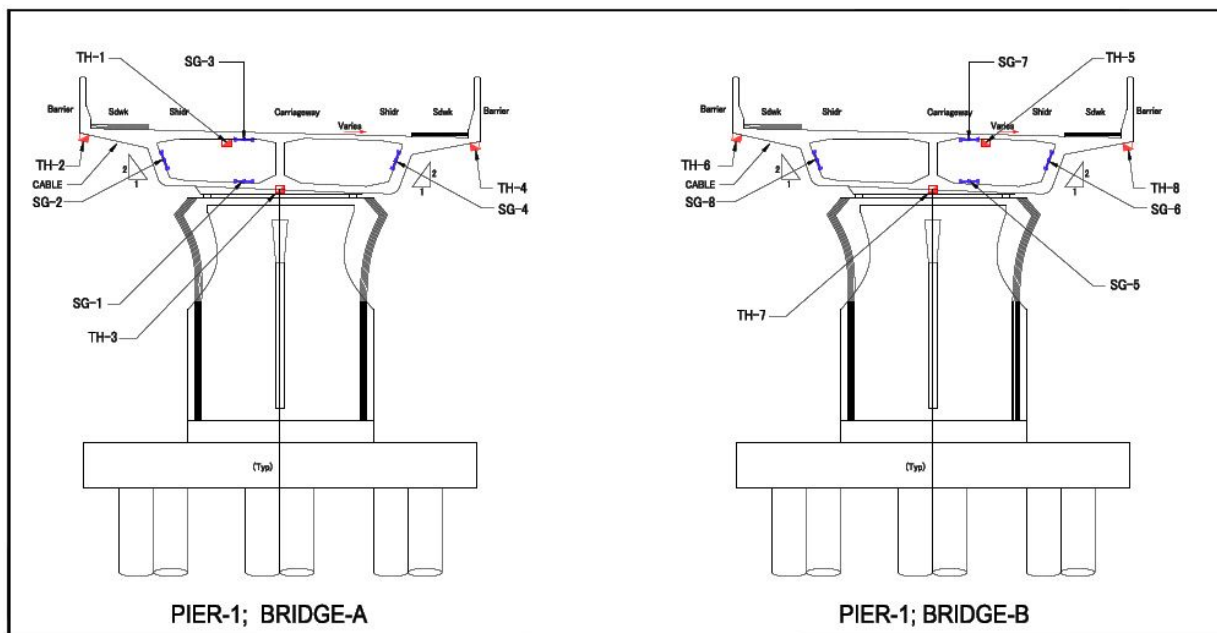

Figure 5 Typical layout plan of strain gage and temperature sensor installation on the bridge

As the road bridge had busy traffic, monitoring was critical. As decided by the Consultant, the strain gages were being monitored every 15 minutes with automatic dataloggers. The data was transmitted in real time to our database management system. All the stake holders could view the data in meaningful information, at their desktops, laptops, notepads or mobile phone. Moving average of the data was considered, to ensure accuracies and address 'outliers' like traffic movements on bridge, temperature effect, heavy vehicle movements for construction, etc.



Though the strain gages had in-built thermistors for temperature readings, additional temperature sensors were also installed on the bridge to discern between structural movements due to ambient temperature and to also understand seasonal adjustment factors due to temperature.

An incidence regarding effect of temperature on the strain gage reading was seen during the period of November 13 to November 27, 2016. The temperature data showed a temperature variation of 4.4°C. During this period the change in strain reading was 10 micro strain. For online display of the strain reading, a correction of 10 micro strains per 4.4°C was made. Refer to figure 6, 7 & 8 for the graphs of temperature, strain data without temperature correction and temperature compensated data of the strain gage.

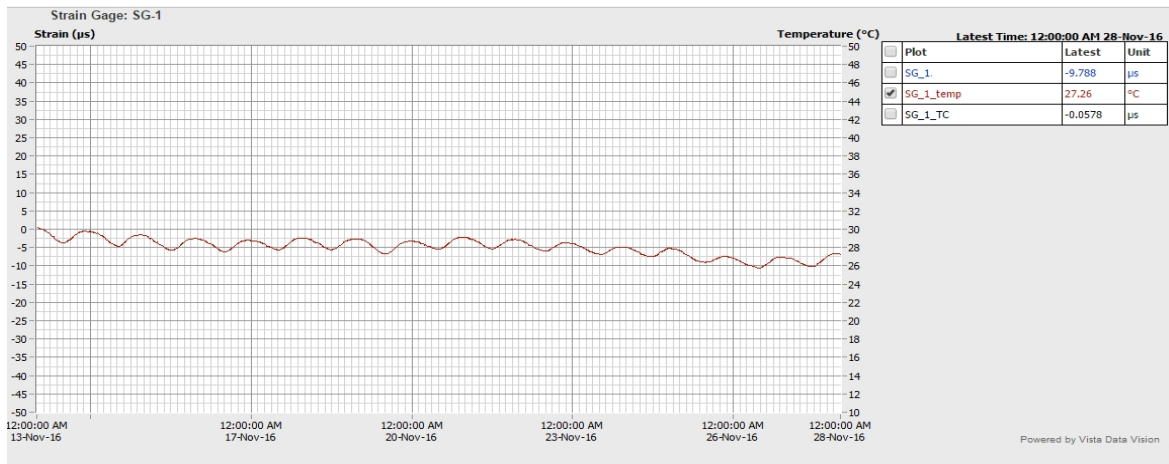

Figure 6 Temperature variation of 4.4°C observed during November 13 to November 27, 2016

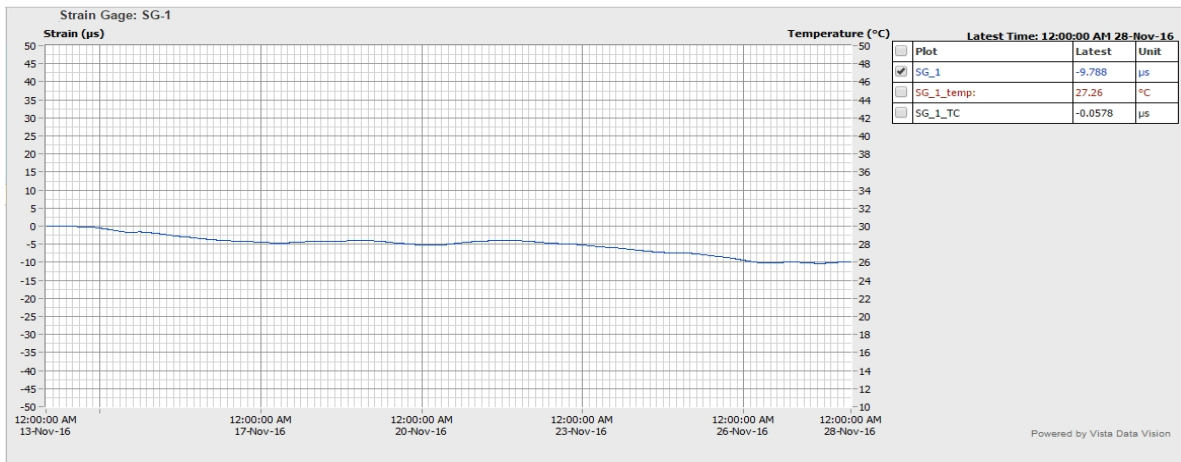

Figure 7 Monitoring data of strain gage SG-01 with temperature effect

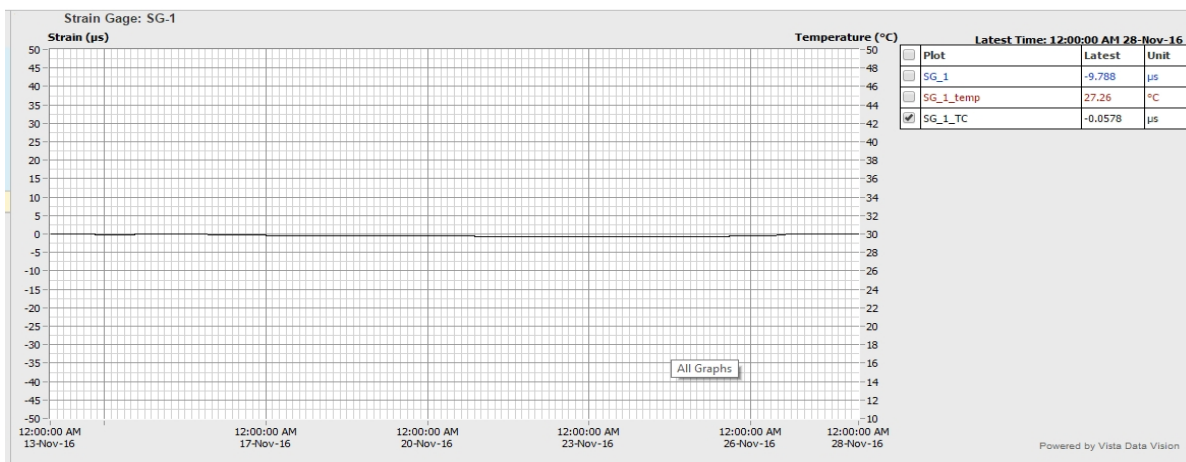

Figure 8 Monitoring data of strain gage SG-01 after correcting temperature effect

For analysis purpose it is to be noted that strain gages did not measure the actual strain/stress in the structure; these measured only the values of change in strain/stress from the date of their installation. The structure of the bridge is already stressed in compression at some locations and in tension in others. This change in strain/stress is, therefore, an addition/subtraction of the strain/stress existing in the structure at the time the strain gages are installed.

Prism targets

Monitoring 3D movements of the bridge were vital to ensure there was no structural impact on the bridge due to ongoing site activities. Prism targets were installed on the bridge to monitor 3D movements. Three automatic total station with control boxes were used to collect and transmit the prism targets data at every 20 minutes.

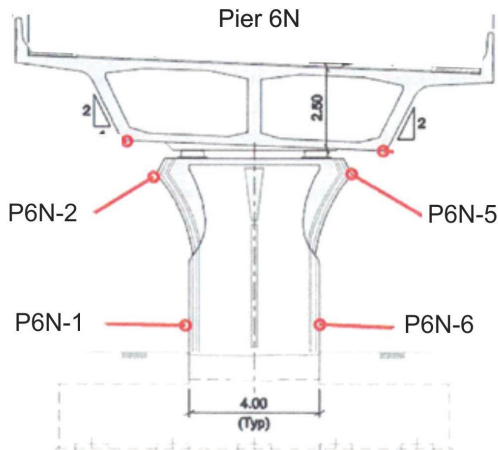

Figure 9 Prism target locations on the bridge pier (left). Automatic total station to collect and transmit data from prism targets installed on bridge (right)

The data from prism targets was put in Tony Gee's spreadsheet. This spreadsheet was developed by bridge designer-Tony Gee, in which differential settlements and lateral movement of the bridge were taken into account. Pier movements were checked against the actual design capacity of the bridge deck section. Refer to figure 10 for Tony Gee spreadsheet.

Challenge

Encardio-rite software team had to make suitable modification to the original database software in order to:

- Automatically input the results in the Tony Gee spreadsheet
- Automatic reading of the results and automatic notification in case of alarm (SMS and emails)
- Upload the report to web cloud under the 20 minutes reporting regime

For each pier, 4 prisms were taken into account for the analysis. Two prisms on the top of the pier, two prisms on the bottom of the pier (refer to figure 9). The database software also averaged the values of prisms at same level of the piers.

Survey Point Record Sheet										Name of Surveyor:
Bridges N2 and N3										Date:
SURVEY INPUTS										
Top Survey Point Values average- LATERAL										
P6	P7	P8	P9a	P9b	P10	P11	P12	P13	P14	mm
-0.3	-0.7	0.5	0.5	0.5	-0.9	-0.3	0	0	0	
Average value of prisms P6N-2 and P6N-5 for lateral movement to bridge										
Bottom Survey Point Values average- LATERAL										
P6	P7	P8	P9a	P9b	P10	P11	P12	P13	P14	mm
0.1	-0.2	-1.5	0.7	0.7	-0.2	-0.1	0	0	0	
Average value of prisms P6N-1 and P6N-6 for lateral movement to bridge										
Vertical displacement average										
P6	P7	P8	P9a	P9b	P10	P11	P12	P13	P14	mm
-0.6	0.3	0.0	-0.6	-0.6	0.3	0.9	0	0	0	
Average value of prisms P6N-1 and P6N-6 for vertical movement bridge										

Figure 10 Tony Gee spreadsheet with data from prism targets



The system automatically compared the results inputted into the Tony Gee spreadsheet to pre-set alert values and provided the alarms when required. Figure 11 shows alert status, where Green denotes "OK" status and Orange denotes "Action" or "Overloaded" alarm.

RESULTS									
Lateral Bearing Capacity Result									
P6	P7	P8	P9a	P9b	P10	P11	P12	P13	P14
OK	OK	OK	OK	OK	OK	OK	OK	OK	OK
Vertical Bearing Capacity Result									
P6	P7	P8	P9a	P9b	P10	P11	P12	P13	P14
OK	OK	OK	OK	OK	OK	OK	OK	OK	OK
Pier Rotation Check									
P6	P7	P8	P9	P10	P11	P12	P13	P14	
OK	OK	OK	OK	OK	OK	OK	OK	OK	
Max Deck Stresses S2				Max Deck Stresses S3					
Point 1	Point 2	Point 3	Point 4	Point 1	Point 2	Point 3	Point 4		
-1.62E+00	1.64E+00	-1.29E+00	1.00E+00	-5.20E-01	-1.71E-01	-2.35E+00	2.52E+00		
OK	OK	OK	OK	OK	OK	OK	OK		

Figure 11 Alert status from the Tony Gee spreadsheet results

The data was also presented in graphical format wherein as a summary of the day, daily monitoring reports of 3D deformation data using the values from 7 AM to 7 PM from the automatic monitoring were plotted and displayed.

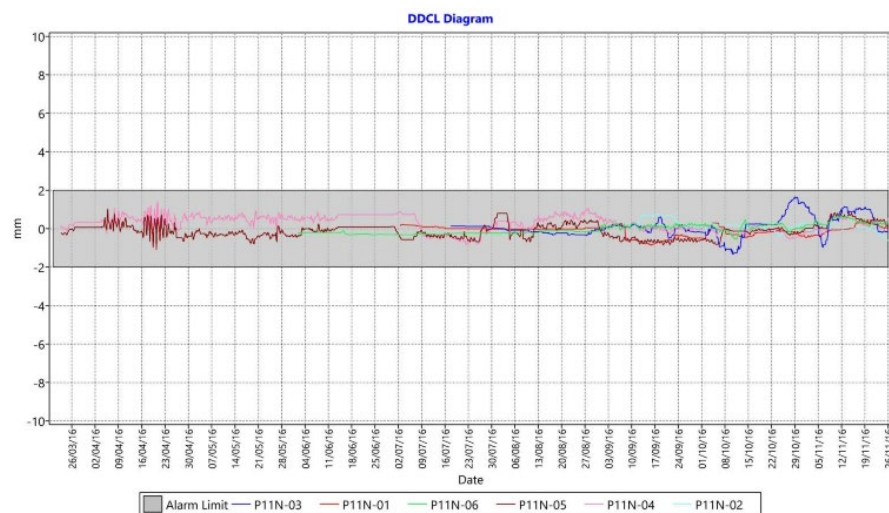
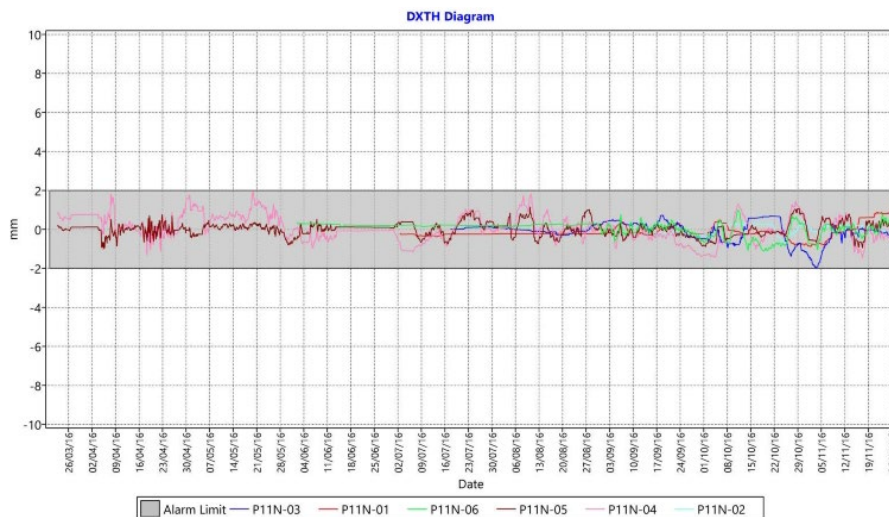

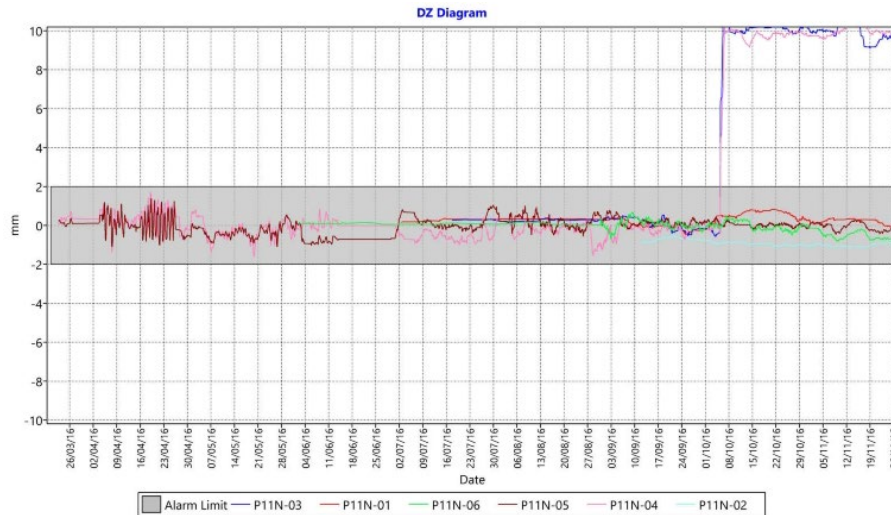

Figure 12 Example of the prism data graphs for longitudinal (top), lateral (middle) and vertical movements (bottom)

Cross-checking of 3D deformation data

As per the directives of the main contractor, the bridge was jacked up at the mid-span to achieve a vertically upwards displacement of 10 mm. Readings of 3D prism automatically collected by the ATS showed a movement close to the above value. The exercise proved the sound functioning of the measurement system implemented.

BUILDING MONITORING

Prism targets

Prism targets were used for external monitoring wherein eight monitoring prisms were installed per tower every ten floors.

To monitor the prism targets on building, the survey team prepared a primary network. Stable pillars were used for this to get more accurate readings.

As the building went higher with construction progress, it became difficult to monitor from the established primary network. Thus, a secondary network was established to get precise readings. The team kept checking the network periodically. In case any change occurred, the errors for tweaked. 12 Beacons of Primary Network, 14 Beacons of Secondary Network were established. Measurements were done using GNSS and High accuracy Total Stations & Digital Levels.

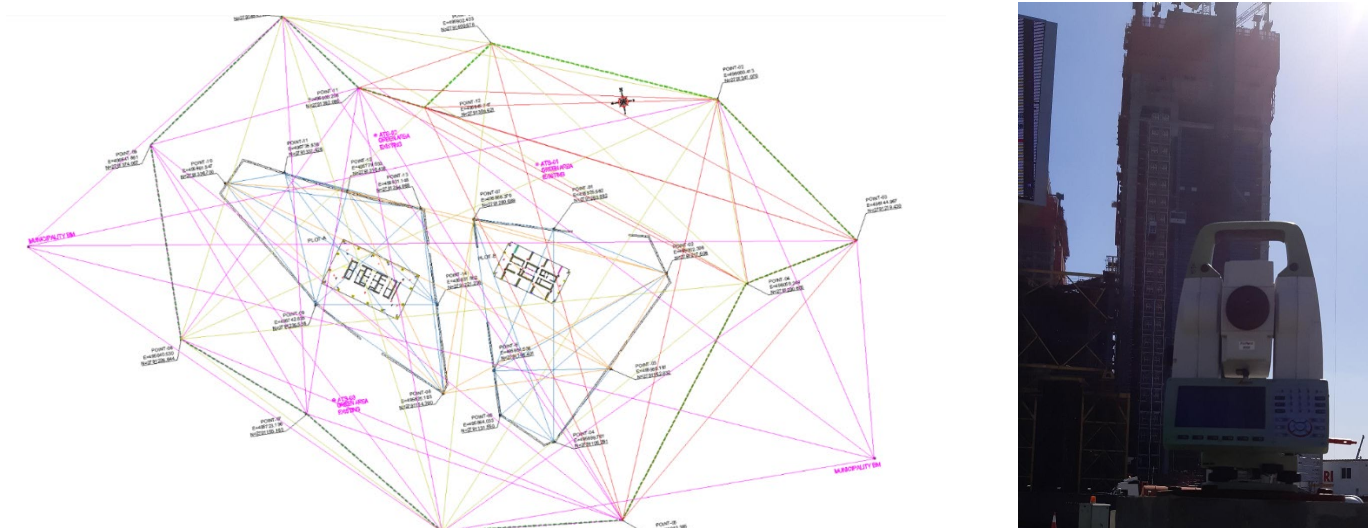

Figure 13 Schematic for optical survey networking (left); Prism targets being monitored by ATS (right)

Laser Plummet

The horizontal alignment of the structure, was monitored along a vertical axis by using a high accuracy Geo Laser plummet LL-91L, having an accuracy of $\pm 1 \text{ mm} \sim 3 \text{ mm}/200 \text{ m}$.

To establish a Vertical Axes Network, ten openings on each slab of Tower A & B, were made without any obstruction from bottom to top.

Every measurement in the grid was recorded as the monitoring reading. It was then converted into picture, recorded and sent to the data base. Each hole had a unique code shown in each picture. The picture also included day, time, position and measurement (laser projection). This prevented any risk of error

To summarise the procedure, Laser plummet created vertical lines at given positions of known coordinates. This helped in:

- Measuring their distances from the core and compare them with the theoretical ones. This way team could calculate any possible deformation of the towers quickly.
- Vertical transferring of known coordinates through the towers. This way, in every floor team could have additional known points that could be used for resections.

Each measurement on the grid directly showed the relative displacement of the slab when it was compared with the initial reference value of the first measurement on the grid.

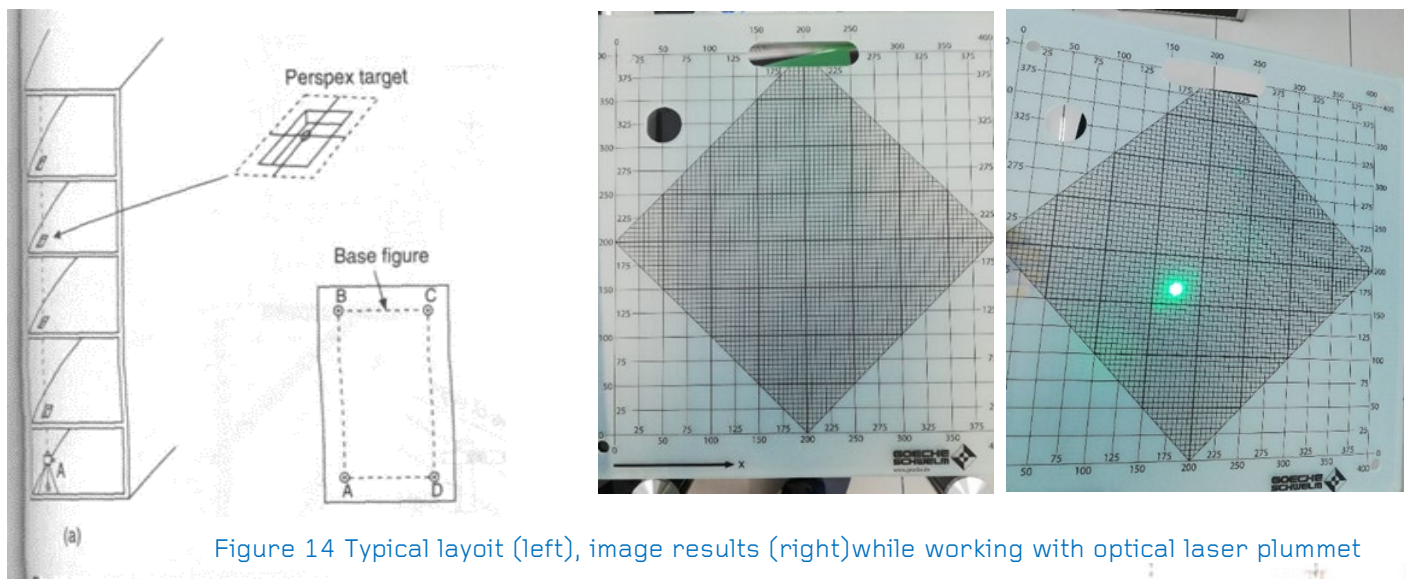

Figure 14 Typical layout (left), image results (right) while working with optical laser plummet

Levelling pins

Levelling pins were installed for internal monitoring vertical alignment.

These were installed as follows:

- At a grid of 30 no.
- All the floors of each Tower
- At a grid of 60 no.
- All the floors of Link Bridge

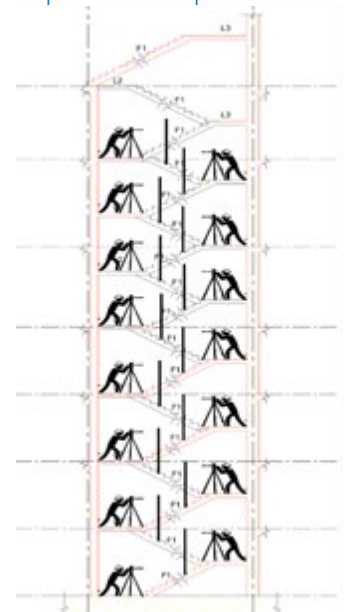



Strain gages

Vibrating wire arc weldable strain gages and embedment strain gages were installed in selected columns of the Towers A & B for stress measurement. The strain gages were also used to estimate axial shortening experienced in load-bearing concrete columns and walls.

It can be expressed as the summation of:

- elastic strain caused by load application,
- shrinkage strain caused by drying of concrete and
- creep strain induced by sustained stress over a long-term period.

Concrete columns and walls can potentially shorten at different rates within the same floor resulting in differential shortening. The strain gages were installed across a number of floors, from initial construction period to the completion of the structure with full service loads applied.

Calculation:

$$\text{Strain} = \Delta l / L; \quad \text{so } \Delta l = \text{strain} \times L$$

Where, Δl = change in length, L – 150 mm (active gage length of strain gage)

Loads considered in the reports are:

- Construction Dead Load
- Construction Live Load
- Wind Load
- Temperature Load
- Impact Load
- Seismic Load

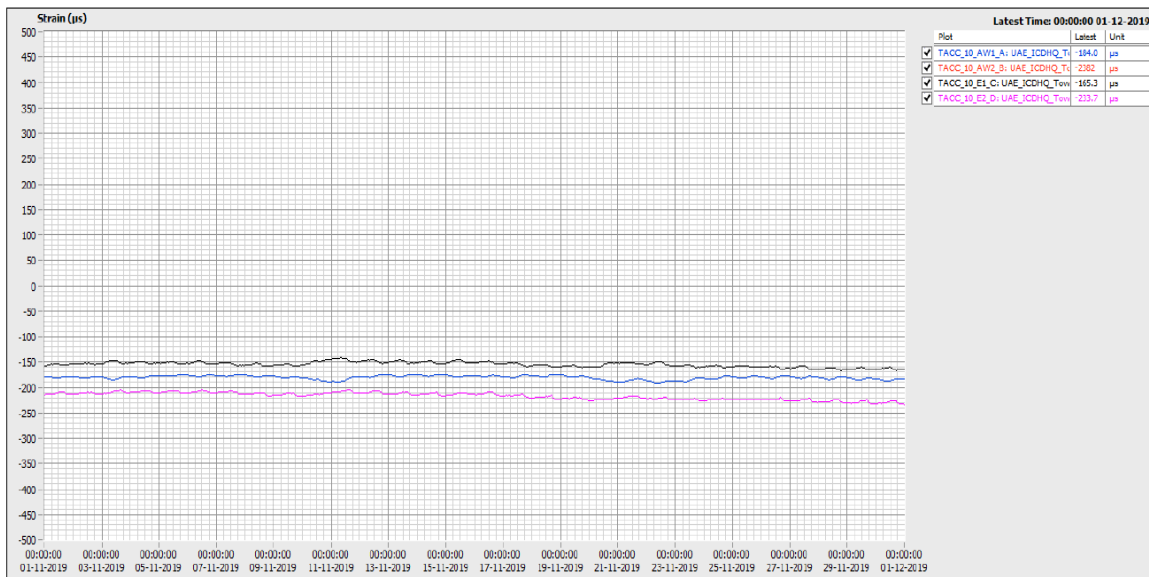

Figure 15 Typical monitoring result from strain gages

Tilt meter

The horizontal displacement of structure is an important indicator for assessing structural performance and safety. If the horizontal displacement of the structure is too large, it will result in an unsafe structure.

Tilt meters were used in Towers A & B, to monitor tilt, to provide data to evaluate the amount of tilt occurring during construction. Tilt meters were installed on selected columns of selected floor. The tilt was converted into a lateral shift. When the displacement value exceeded pre-set safe value, stake holders were informed who then took appropriate measures in advance.

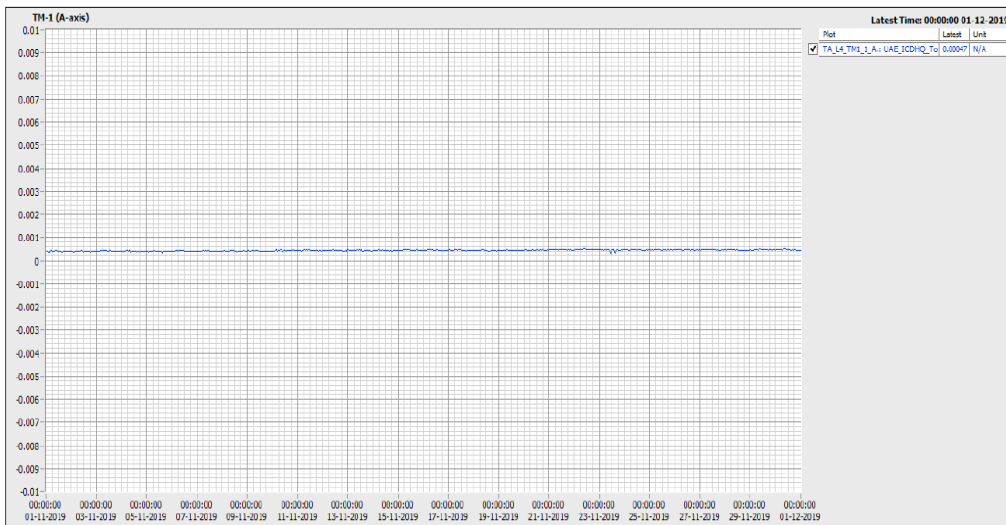

Figure 16 Typical monitoring result from tilt meter

LINK BRIDGE MONITORING

As discussed earlier, Towers A & B were linked by a suspended bridge, floating between 24-27th floor of the towers. This was one of the world's largest cantilever link bridge.

To measure the deformation, 4 no. prisms were used at the bridge edge at every 20 m interval. Monitoring of link bridge continued during sliding phase and also after it was fixed with the structure. The prism targets were monitored with automatic total station with control boxes.

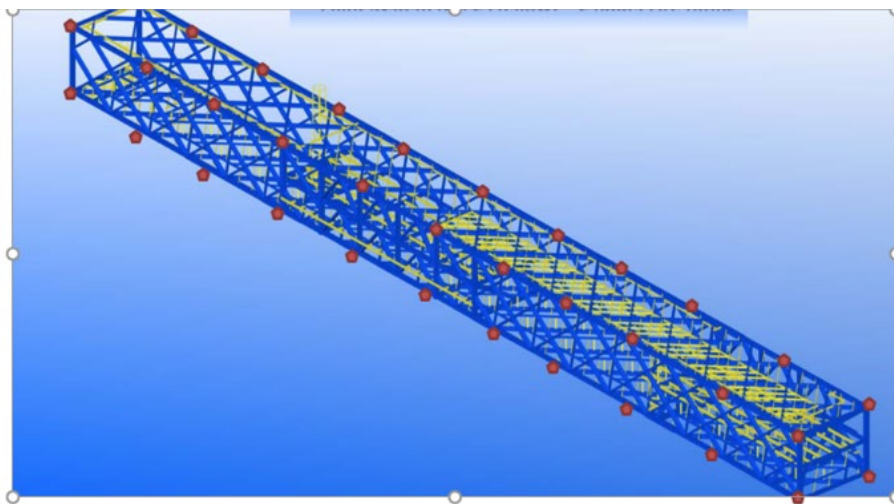

Figure 17 Link bridge layout

RESULTS

The design team had modelled the structure deformation of Towers A & B, after permanent fixing of link bridge into it (predicted deflection given below in figure 19). In order to verify the design model, the above mentioned instruments i.e tilt meter, strain gauge, prism targets and laser plummet gave sufficient data in meaningful information, at required frequency, at stake holder's desk.

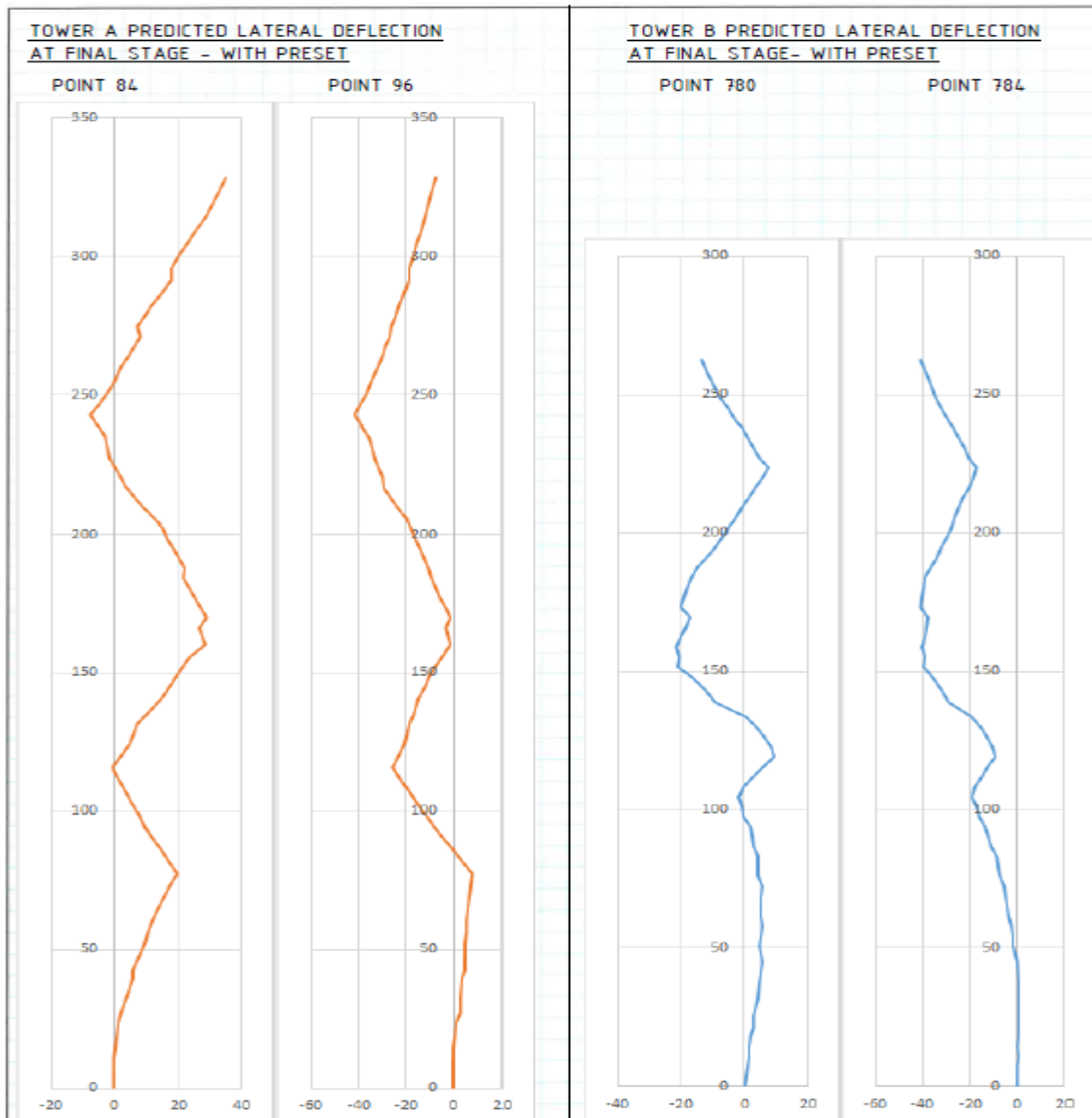

Figure 18 Typical structure deformation model

CHALLENGES

- Monitoring of Link Bridge was very challenging as it was difficult to have line of sight for monitoring the prism targets used for 3 direction movement of the bridge.
- Monitoring the verticality of such high towers was also challenging.
- Installation of strain gages in the existing bridge was challenging, as installation was done inside bridge viaduct with confined space and little natural light from the service openings. No artificial sources of lighting could be used. A lot of pre-preparation work was done by team following the 'confined space safety norms'
- Maximizing the baseline data was challenging. One had to understand the seasonal adjustments and effects. Also the team had to cater other factors than expected, which pre-existed and were affecting conditions monitoring. For example, there was a temperature variation during 13th-27th November was 4.4°C, which was an unusual variation in a short period for this geographical location
- Changing line of site for optical surveying, as construction works progressed, posed a challenge. Survey team tried to pre-determine the line of sight with modelling software, thinking ahead about access to monitoring



- Due to construction activities, dirt used to deposit on the prism targets. Cleaning the prisms at height at regular intervals was challenging, as it required pre-planning to get lifting equipment for access
- Power source for the automatic total stations (ATS) and control boxes became challenging as they were fixed in the median. Thus, direct power from power line could not be given. Diesel generator had issues of power drop outs, or sudden surges, due to which we lost some data. Then it was decided to use solar power. But solar panel again lost charging due to mist. Finally team designed a system to have 3 day autonomy combined with diesel generator and solar panels.
- De-watering monitoring was very critical. It could be too fast or too slow; else it risked effecting the ground conditions, resulting in structural movement. Thus, cross effects of water levels was interpreted with any detected movement.

Encardio-rite's World class instruments and expertise in the field helped to monitor such iconic structure meeting the precision standards required for the project.

DATA COLLECTION AND PRESENTATION

Data from all the strain gages, temperature sensors, tiltmeter were collected and transmitted by automatic compact dataloggers. Data from prism targets was collected and transmitted at desired frequencies by automatic total stations with control boxes that had in-house developed software that allowed to control the ATS remotely. All the data was transmitted to a central server with our in-house developed database management system. The data was accessible to all the stake holders, in near real time, with advance alerts and warning system.

Daily, weekly and monthly monitoring reports were also prepared and submitted including the real time online data as well as the manually monitored data from inclinometers and standpipe piezometers. Graphs of the previous week data, as well as graphs of the historical data, were included. In case of any variation observed in data, field report or incidence report was included. It also comprised of site progress pictures, instrumentation layout drawings. The comprehensive reports/alerts helped the stake holder in precise evaluation of field data and implementing preventive/corrective actions timely where required.

ACHIEVEMENT & CONCLUSION

The well planned monitoring system implemented at critical construction site, located at the heart of a metropolis, helped in reducing risks, protecting existing assets and giving confidence to the construction process. The purpose of instrumentation and monitoring is not only limited to design optimization and construction control but also to ensure the safety and stability of the work at construction site and the infrastructure within zone of influence.

Monitoring data was made available to all stakeholders seamlessly almost in the real time, in meaningful information, with advance warnings and alerts. This was possible with a combination of rugged sensors, advanced data collection and telemetry using the GSM network and web-based data monitoring service.

The successful execution of such a complex project, within stipulated time, highlights importance and advantages of a well-executed instrumentation plan by experienced instrumentation and monitoring company.